

KNIPEX Quality – Made in Germany



# KNIPEX Electrical Range

Further products on  
[www.knipex.com](http://www.knipex.com)





## Pliers for the electrical sector

Professional users in the electrical industry will find that KNIPEX offers them a comprehensive range of essential standard and special pliers for installation, assembly, repair and maintenance activities.

Diagonal cutters, cable shears, wire strippers and stripping tools, crimping pliers – the list is long. When you're working on cables, connectors, electrical and electronic systems, you'll find that KNIPEX has the right tool for almost any task that arises.

For over 135 years, KNIPEX pliers have been a flagship for products "Made in Germany" - with their own drop forge, mechanical production, hardening, annealing and electroplating shops, all monitored by efficient quality controls at every single step.

Applying engineering skills and a great deal of experience, KNIPEX develops pliers in dialogue with the users, in line with the changing requirements of technologies, markets and industries. Thus, the KNIPEX name has become synonymous with functionality, user convenience and longevity.

This catalogue contains a selection of our extensive range of pliers, which we have put together especially for the electrical sector.

- > The KNIPEX Twistor16® self-adjusting crimping pliers with its 360° rotatable crimping die can compress wire ferrules up to 16 mm<sup>2</sup> from almost any working position.
- > The KNIPEX TwistCut® allows you to cut corrugated pipes between 16 and 32 mm in diameter quickly and with no risk for cables and fingers. The practical 2-in-1 tool also offers stripping devices for wires between 0.2 and 4.0 mm<sup>2</sup>.
- > The award-winning KNIPEX ErgoStrip® universal stripping tool is also perfect for left-handed use: The KNIPEX ErgoStrip® L means that left-handed users can now also strip and dismantle all kinds of household electrical cables quickly and effectively.

More information about our products can be found in this catalogue.

## SYMBOLS

	flat jaws		with lead catcher
	half-round jaws		angle
	round jaws		weight
	flat and pointed jaws		length
	box-joint		centre cutter
	bolted joint		cutting edges with bevel
	smooth gripping surfaces		cutting edges with small bevel
	knurled gripping surfaces		cutting edges with very small bevel
	cross-hatched, knurled gripping surfaces		cutting edges without bevel
	with opening spring		for flush cut of soft materials

	electrostatic discharging, dissipative		soft wire
	electronics		medium hard wire
	VDE-tested, also in compliance with GPSG insulated according to IEC 60900, usable up to 1000 V AC / 1500 V DC		hard wire
	conforms to a European directive		piano wire
	mechanically tested in accordance with the equipment and product safety act		Cu + Al-multi-conductor cable, solid and multi-stranded
	WEEE marking (Waste Electrical and Electronic Equipment Directive)		wire rope
			iron
			ribbon cable
			steel wire armoured cable (SWA)

# Insulated tools are a matter of trust

Professionals trust their tools. This trust is vital when working on electrical installations. An electrician holding pliers is also holding his life in his hands. Our insulated tools therefore not only meet statutory requirements, but also offer the greatest possible safety, reliability and performance.

## Regulated by standards

Only trained professionals are allowed to work on live installations. Such work is subject to strict occupational health and safety standards such as the German DIN VDE 0105 and the international EN 50110 and IEC 60364. In each case they must deploy special tools that have been specifically manufactured and tested for this work. Which requirements have to be met by tools used in live work is determined by DIN EN / IEC 60900. KNIPEX tools which bear the special mark  1000V are approved for work up to 1000 V AC.

## Individual checks guaranteed

Every insulated tool undergoes, one by one, a dielectric strength test at 10,000 V AC before we sell it. This guarantees a reassuring safety buffer. Other procedures check the reliability of the insulation towards heat, cold, tensile and impact force. In addition to the KNIPEX quality assurance system certified to ISO 9001, external institutes and test centres such as the VDE guarantee that all VDE criteria have been satisfied. We go through this effort to safeguard the users. They trust their well-being with our pliers, day in and day out. In return we want to give them the best possible safety at all times. We stand by this responsibility on the insulation of KNIPEX tools.

## Strong beneath the insulation

The insulation provides safety when handling electrical installations, but it does not cut, grip or crimp. The mechanical properties of the basic tool, such as cutting performance, precision and stability, therefore style part of the overall quality of insulated tools.

With our insulated pliers, users can depend on the quality and durability of products from KNIPEX production. For assembly tools insulated by us, we use basic tools from tried and tested suppliers whose quality we subject to regular, stringent checks. The expert can rely on this double dependability of tool and insulation.



Testing dielectric strength, subjecting each pair of pliers to a load of 10.000 V AC.



Testing the adhesion of the VDE insulating grips with 500 N at 70° C.



Pressure test at 70°C.



Low temperature impact test at -25°C.



Testing the electrical insulating properties.



# VDE-tested tools with drop protection system

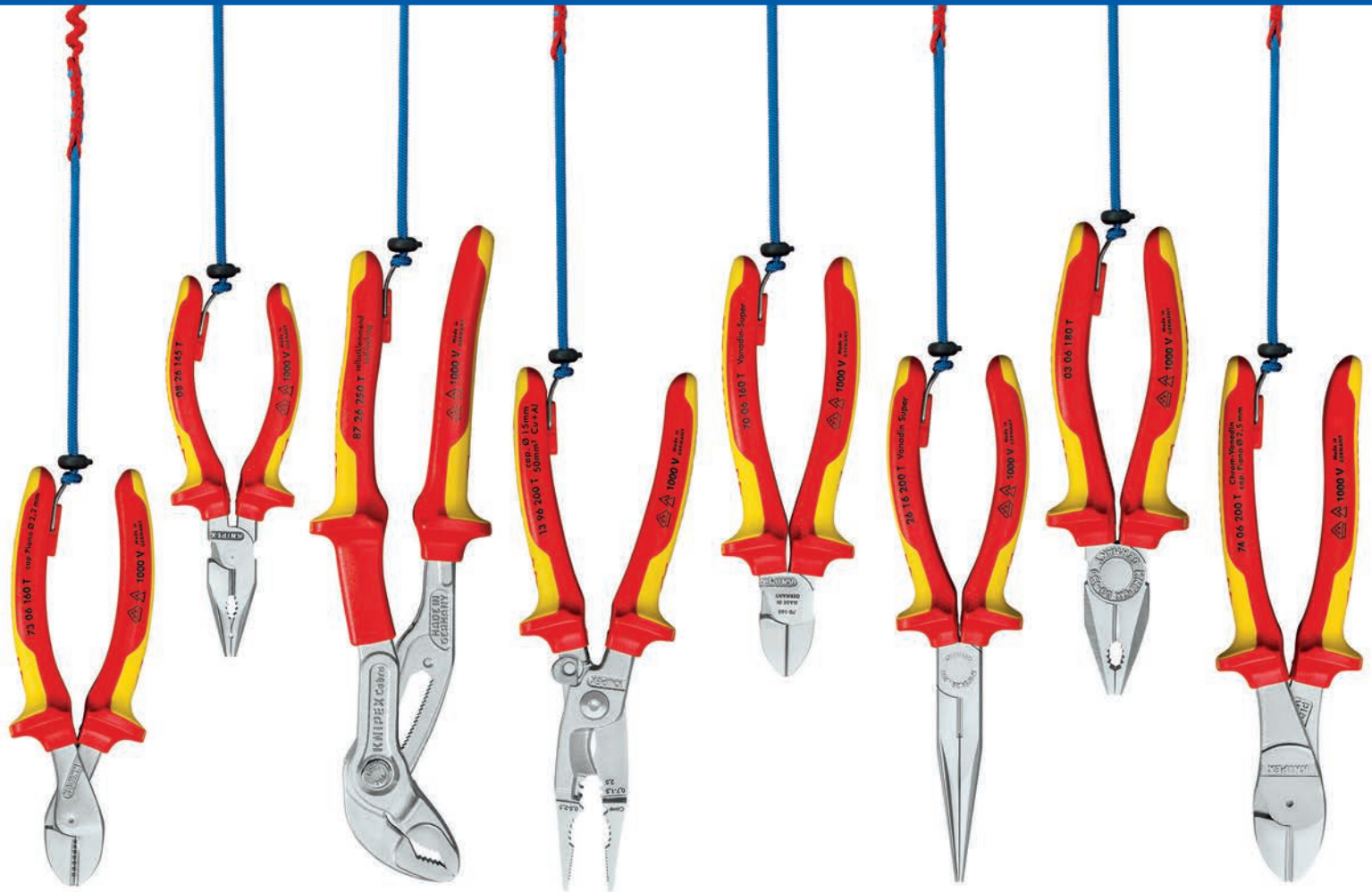

# KNIPEX Tethered Tools, VDE-tested







Flexible drop protection system

T

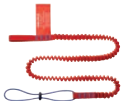















Working at heights and live line working are associated with greater risk

Using the Tethered Tools versions of the individually tested KNIPEX VDE pliers significantly reduces hazards caused by falling tools

- > 16 different models of insulated KNIPEX pliers available in a Tethered Tools version (others on request)
- > Tool is reliably protected by a tether, adapter strap and material carabiner
- > Doubly safeguarded work: extremely stable tether attachment welded tightly to the handle, for attaching a tether
- > Tether attachment does not get in the way during unsecured work on the ground
- > Handles with insulating multi-component grips, additionally tested for stress from heat, cold, tension and impact; tested in accordance with DIN EN/IEC 60900. VDE

	Article No.	Contents
<b>Tool protection system for tools with tether attachment: effective protection against accidents caused by falling tools</b>		
	00 50 01 T BK	1 x tether large working radius: the gathered fabric tape expands when under strain to a length of up to 1.5 m
	00 50 02 T BK	3 x adapter straps, flexible connection between tool and secure attachment point
	00 50 03 T BK 	2 x carabiners, screw lock screwed tight prevents the material snap hook opening unintentionally
	00 50 04 T BK 	Tethering system set, for versatile ways of attaching KNIPEX pliers to a tether attachment (1 x tether, 3 x adapter straps, 2 x carabiner)

Our tool securing system is also suitable for our wide range of VDE-tested screwdrivers

	Article No.	Contents
<b>VDE-tested pliers with integrated insulated tether attachment for attaching a fall protection mechanism</b>		
	03 06 180 T chrome plated	Combination Pliers, with gripping zones for flat and round material
	08 26 145 T chrome plated	Needle-Nose Combination Pliers, working in confined areas thanks to slim head design
	11 06 160 T chrome plated	Insulation Stripper, for single, multiple and fine stranded conductors with plastic or rubber insulation
	13 96 200 T chrome plated	Pliers for Electrical Installation, multifunctional pliers for the electrical installation
	13 66 180 T chrome plated	KNIPEX StriX®, Insulation Stripper with Cable Shears
	25 06 160 T chrome plated	Snipe Nose Side Cutting Pliers (Radio Pliers), suitable for finer gripping and cutting work, half-round, long, pointed jaws
	26 16 200 T chrome plated	Snipe Nose Side Cutting Pliers (Stork Beak Pliers), highly loadable, elastic precision points, flat rounded, long jaws
	26 26 200 T chrome plated	26 16 200 T: straight 26 26 200 T: bent
	70 06 160 T chrome plated	Diagonal Cutter, Slim head for use in inaccessible work areas; available with fall protection in a compact length of 160 mm and a robust 180 mm length
	70 06 180 T chrome plated	
	73 06 160 T chrome plated	KNIPEX X-Cut®, Compact Diagonal Cutter for very tough, continuous use
	74 06 200 T chrome plated	High Leverage Diagonal Cutter, high cutting performance with minimum effort, available with fall protection mechanism in lengths of 200 mm and 250 mm
	74 06 250 T chrome plated	
	87 26 250 T chrome plated	KNIPEX Cobra® VDE, Hightech Water Pump Pliers, insulated, adjustment by shifting one jaw directly onto the workpiece and nuts
	95 16 165 T chrome plated	Cable Shears, precision ground, hardened blades: clean and smooth cut without crushing and deformation
	97 78 180 T polished	Crimping Pliers for wire ferrules, secure crimping in 9 marked half-round dies with tapered side surfaces



The through hole on the handle of all KNIPEX screwdrivers permits connection to our tool securing system, illustrated here on the handle of our new KNIPEX "Slim" screwdriver for PlusMinus profile screws.

# New products 2020



## KNIPEX PreciStrip16 | p. 8

Automatic Insulation Stripper

12 52 195



## KNIPEX StepCut | p. 7

Innovative step cut

95 11 160

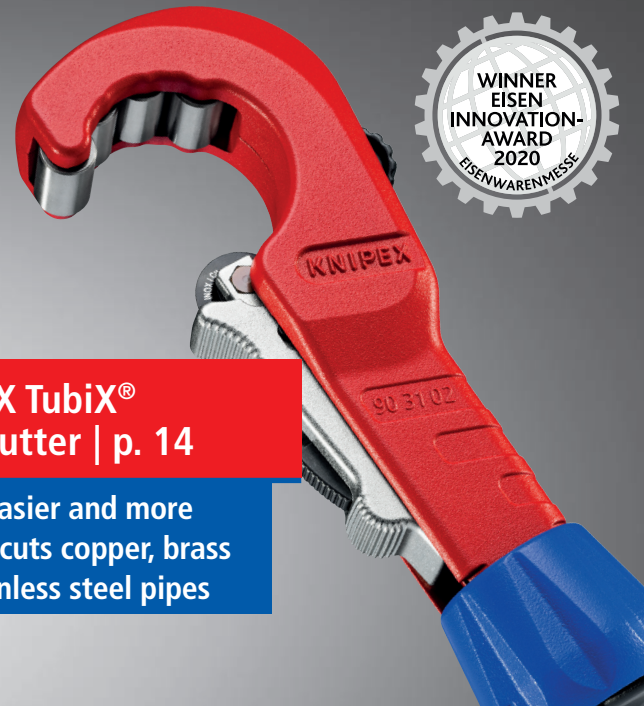

## KNIPEX TubiX® Pipe Cutter | p. 14

Faster, easier and more precise: cuts copper, brass and stainless steel pipes

90 31 02

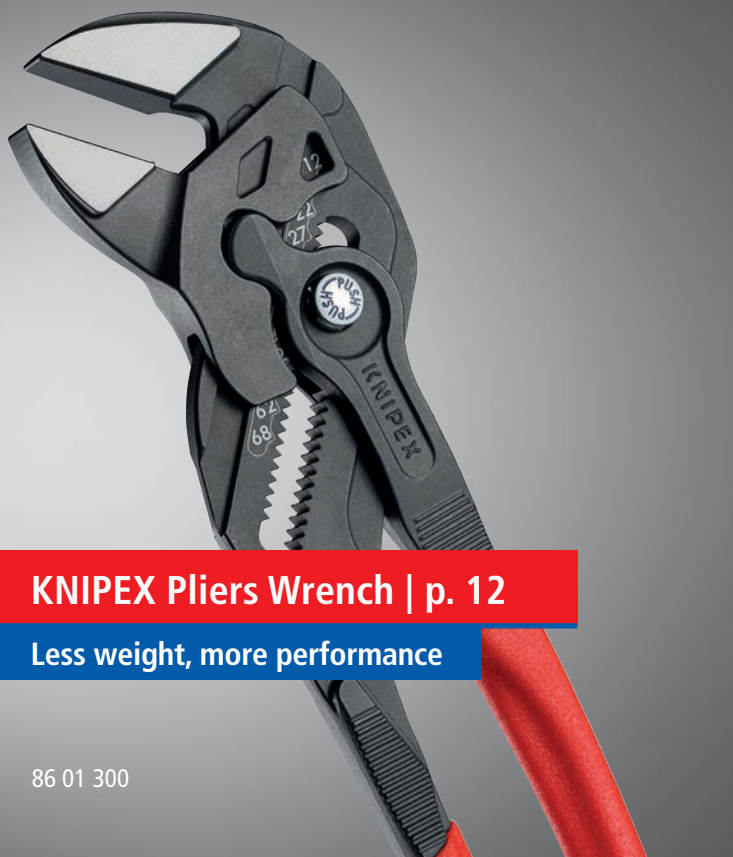

## KNIPEX Pliers Wrench | p. 12

Less weight, more performance

86 01 300

## KNIPEX Cobra® XS | p. 10

Now in a 100 mm model



87 00 100

**Cable cutting made easy: innovative step cutting separates wires one by one to save energy**

**Small, light, strong: comfortable cutting without crushing and just 160 mm in size**

**Noticeably less effort: the gradations cut wires one after the other; cutting is up to 40 % easier than with standard cable shears of the same length!**

**Ergonomic handle design: optimal cutting feel even for larger cable diameters**

- > Cuts multi-core stranded copper and aluminium cables up to Ø 15 mm (50 mm<sup>2</sup>)
- > Cuts solid copper and aluminium cables up to 5 x 4 mm<sup>2</sup>
- > Cuts without crushing
- > Bolted joint: precise, effortless, durable
- > Pinch guard fitted for safe work
- > Not suitable for steel wire and hard drawn copper conductors
- > Cutting edges additionally induction-hardened, cutting edge hardness at least 56 HRC
- > High-grade special tool steel, forged, oil-hardened

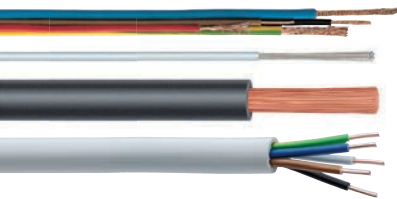

**NEW**  
PAT. PEND.



95 11 160



95 12 160

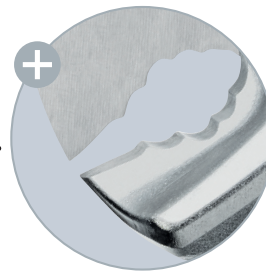

The gradations cut wires one after the other, without crushing



95 16 160



Cuts solid Cu- and Al-cable up to 5 x 4 mm<sup>2</sup>



Bolted joint: precise, smooth-running, durable; with pinch guard

Article No.	EAN 4003773-	↔ mm	Werkzeug	Griffe	Cutting capacities				
					Ø mm	mm <sup>2</sup>	AWG	g	
95 11 160	085904	160	burnished	plastic coated	15,0	50	1 / 0	180	
95 11 160 SB	085911	160	burnished	plastic coated	15,0	50	1 / 0	205	
95 12 160	085928	160	burnished	with multi-component grips	15,0	50	1 / 0	220	
95 12 160 SB	085935	160	burnished	with multi-component grips	15,0	50	1 / 0	245	
95 16 160	085966	160		chrome plated	insulated with multi-component grips, VDE-tested	15,0	50	1 / 0	225
95 16 160 SB	085898	160		chrome plated	insulated with multi-component grips, VDE-tested	15,0	50	1 / 0	250

Capacity of  
0.08–16 mm<sup>2</sup>

## KNIPEX PreciStrip 16

Automatically strips insulation – and thanks to additional zero correction, it also grips where automatic devices would otherwise fail

**KNIPEX**®

12 52 195



**Properly stripped away:**  
with deft precision, strip everything from very fine to thick cables with stranded or solid conductors

Simple, precise stripping of fine stranded and solid round cables with a wide capacity range from 0.08 to 16 mm<sup>2</sup> with only one pair of pliers

Good grip provided by semi-circular grooved metal holding clamps and exact cut from parabolic stripping blade

Fine adjustable zero correction of the blade setting to special material requirements, e.g. due to large temperature differences

- > With cable cutter for stranded wire from 0.08 to 16 mm<sup>2</sup>
- > With tether attachment point, suitable for KNIPEX Tethered Tools accessories
- > Inscription area for customisation
- > With adjustable length stop for precision work repeated accurately each time
- > Comfortable operation with ergonomic dual-component handle
- > Easily replaceable blade cassette

**NEW**  
PAT. PEND.



12 52 195

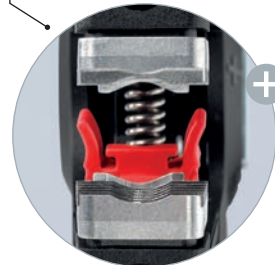

Parabolic blade separates the insulation first and then automatically pulls it back



Customisable using the inscription area

**How parabolic blades work**  
The parabolic bulging blade pair (red) extensively encloses and cuts the insulation and is thus suitable for many flexible materials

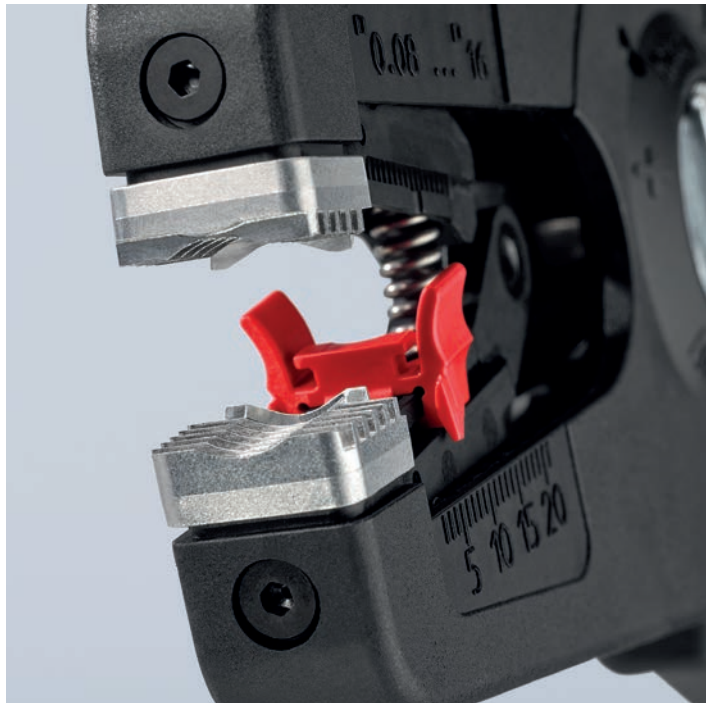

Semi-circular grooved holding clamp for better grip that holds practically any insulation material securely in place



With cable cutter on the top side for up to 16 mm<sup>2</sup>



For special requirements, such as particularly hard or soft insulation materials, optimum fine adjustments can be made using the adjustment wheel with its tactile locking positions

Article No.	EAN 4003773-	↔ mm	⊗ mm <sup>2</sup>	⊗ AWG	⚖ g
12 52 195	<b>N</b> 085829	195	0,08 - 16	28 - 6	180
12 52 195 SB	<b>N</b> 085997	195	0,08 - 16	28 - 6	180
12 49 31	<b>N</b> 086000	Spare blade pair for 12 52 195			10

# KNIPEX Cobra® XS

Only 100 mm in length:  
anything but a toy!



The slim head provides firm grip even in tight spaces



Gripping capacity  
**Ø 28 mm**



Work with only one hand: open, slide in, it fits!



**Grips like a big tool: The smallest water pump pliers in the world with full functional capability**

Optimum access in the narrowest spaces: an especially compact design with a very slim head

Single-handed fine adjustment by sliding for optimal fitting to various workpiece sizes

Long-lasting secure grip ensured by high wear resistance

- > Gripping capacity Ø 28 mm (1"), width across flats up to 24 mm – at only 100 mm length
- > Box joint: high quality and durability provided by dual guide
- > Gripping surfaces with specially hardened teeth, hardness approx. 60 HRC
- > Self-locking on pipes and nuts: no slipping on the workpiece and low handforce required
- > Pinch guard prevents operators' fingers being pinched
- > Fine adjustment with 11 adjustment positions
- > DIN ISO 8976

**NEW**  
PAT. PEND.



87 00 100

**The KNIPEX Cobra® Family has grown**

In every size: perfect tightening, gripping, holding, pressing and bending with the ingenious self-locking effect



87 00 100

87 01 125

87 01 150

87 01 180

87 01 250

87 01 300

87 01 400

87 01 560



Self-locking and durable – all part of genuine KNIPEX water pump pliers



The KNIPEX Cobra® XS grips nuts up to 24 mm and other workpieces as large as Ø 28 mm



Naked truth: The grips are not coated to keep them as slim as possible. To ensure good grip, they are textured on the outside

Article No.	EAN	↔		Pliers	Head	Handles	Adjustment positions	∅ Inch	∅ mm	g
	4003773-	mm								
87 00 100	085836	100		grey atramentized	polished	embossed, rough surface	11	1	24	62
87 00 100 BK	085843	100				embossed, rough surface	11	1	24	87
87 01 125	069935	125				with non-slip plastic coating	13	1	27	85
87 01 150	060116	150					11	1 1/4	30	145
87 01 180	022015	180					18	1 1/2	36	170
87 01 250	022022	250					25	2	46	335
87 01 300	034087	300					30	2 3/4	60	530
87 01 400	005636	400					27	3 1/2	95	1214
87 01 560	044321	560					20	4 1/2	120	2750

**Now optimised: Less weight, more performance, with a larger opening width and a practical laser-cut adjustment scale**

**Higher capacity: Continuous gripping in all wrench sizes up to 68 mm (maximum 2 1/2") with use of two additional adjustment positions**

**Noticeably less weight, 80 grams lighter with the same stability**

**Practical adjustment scale: A laser-cut (metric and imperial) enables pre-setting to the width across flats**

- > Replaces a whole set of spanners – metric and imperial
- > Smooth jaws for damage-free installation of plated fittings - working directly on chrome!
- > Reliable catching of the hinge bolt: no unintentional shifting
- > Lever transmission greater than 10:1 for strong gripping power
- > Chrome vanadium electric steel, forged, oil-hardened

**For especially sensitive surfaces:**  
plastic protective jaw covers are available as accessories for all optimised pliers wrenches

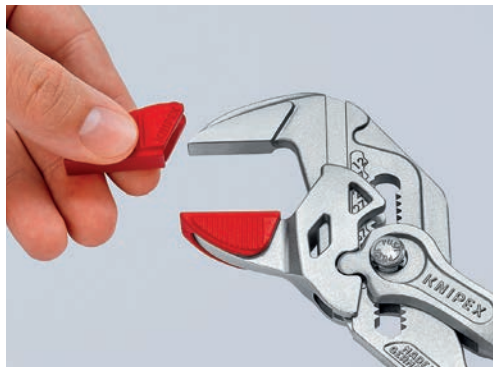

86 01 180 and  
86 03 180



86 01 250 and  
86 03 250



86 01 300 and  
86 03 300

**Even better:  
the optimised pliers wrench**

The new versions of the tried-and-tested pliers wrench. You will recognise them **1** by the offset jaws, **2** the laser-cut scale for pre-setting of width across flats

Article No.	EAN 4003773-	↔ mm		Pliers	Head	Handles	Adjustment positions	⬡ Inch	⬡ mm	⚖ g
86 03 125	077497	125	□	chrome plated		plastic coated	11	7/8	23	105
86 03 125 SB	077688	125	□	chrome plated		plastic coated	11	7/8	23	105
86 03 150	069676	150	□	chrome plated		plastic coated	14	1	27	193
86 03 150 SB	070009	150	□	chrome plated		plastic coated	14	1	27	193
86 01 180	N 084273	180	□	grey atramentized	polished	with non-slip plastic coating	15	1 1/2	40	230
86 01 180 SB	N 084303	180	□	grey atramentized	polished	with non-slip plastic coating	15	1 1/2	40	230
86 01 250	082385	250	□	grey atramentized	polished	with non-slip plastic coating	19	2	52	457
86 01 250 SB	082637	250	□	grey atramentized	polished	with non-slip plastic coating	19	2	52	457
86 01 300	N 084662	300	□	grey atramentized	polished	with non-slip plastic coating	24	2 1/2	68	645
86 01 300 SB	N 084679	300	□	grey atramentized	polished	with non-slip plastic coating	24	2 1/2	68	645
86 02 180	N 084280	180	□	grey atramentized	polished	with multi-component grips	15	1 1/2	40	240
86 02 180 SB	N 084310	180	□	grey atramentized	polished	with multi-component grips	15	1 1/2	40	240
86 02 250	082392	250	□	grey atramentized	polished	with multi-component grips	19	2	52	468
86 02 250 SB	082644	250	□	grey atramentized	polished	with multi-component grips	19	2	52	468
86 03 180	U 035466	180	□	chrome plated		plastic coated	15	1 1/2	40	230
86 03 180 SB	U 028819	180	□	chrome plated		plastic coated	15	1 1/2	40	230
86 03 250	033837	250	□	chrome plated		plastic coated	19	2	52	462
86 03 250 SB	022091	250	□	chrome plated		plastic coated	19	2	52	462
86 03 300	U 041429	300	□	chrome plated		plastic coated	24	2 1/2	68	645
86 03 300 SB	U 040927	300	□	plastic coated		plastic coated	24	2 1/2	68	645
86 03 400	077312	400	□	chrome plated		plastic coated	25	3 3/8	85	400
86 05 180	U 047162	180	□	chrome plated		with multi-component grips	15	1 1/2	40	250
86 05 180 SB	U 052180	180	□	chrome plated		with multi-component grips	15	1 1/2	40	250
86 05 250	047841	250	□	chrome plated		with multi-component grips	19	2	52	485
86 05 250 SB	052029	250	□	chrome plated		with multi-component grips	19	2	52	485
86 06 250	082408	250	□	chrome plated		insulated with multi-component grips, VDE-tested	19	2	52	515
86 06 250 SB	082651	250	□	chrome plated		insulated with multi-component grips, VDE-tested	19	2	52	515
86 09 180 V01	N 085805	3 pairs of plastic jaws for all 86 XX 180 mm models (models from 2019)								9
86 09 250 V01	084143	3 pairs of plastic jaws for all 86 XX 250 mm models (models from 2018)								18
86 09 300 V01	N 085812	3 pairs of plastic jaws for all 86 XX 300 mm models (models from 2020)								24

# All advantages of the optimised pliers wrenches at a glance:

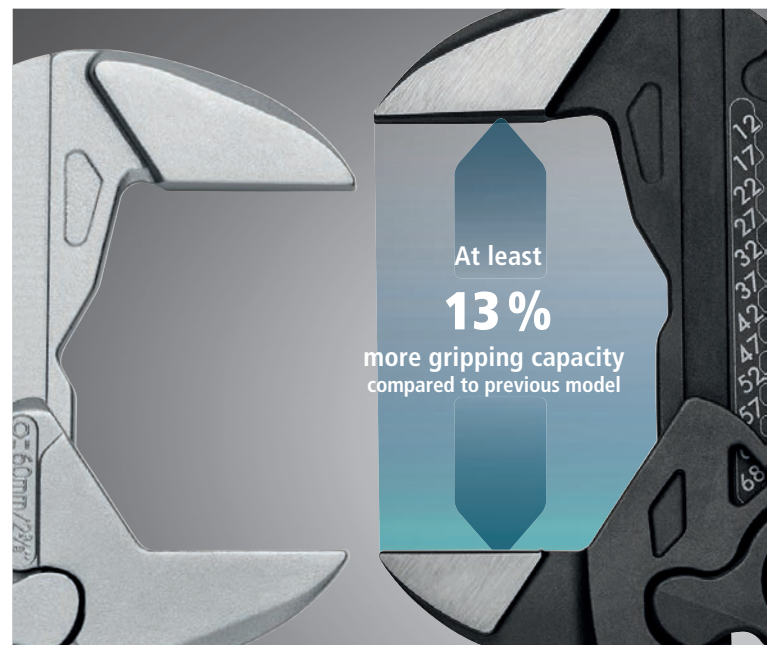
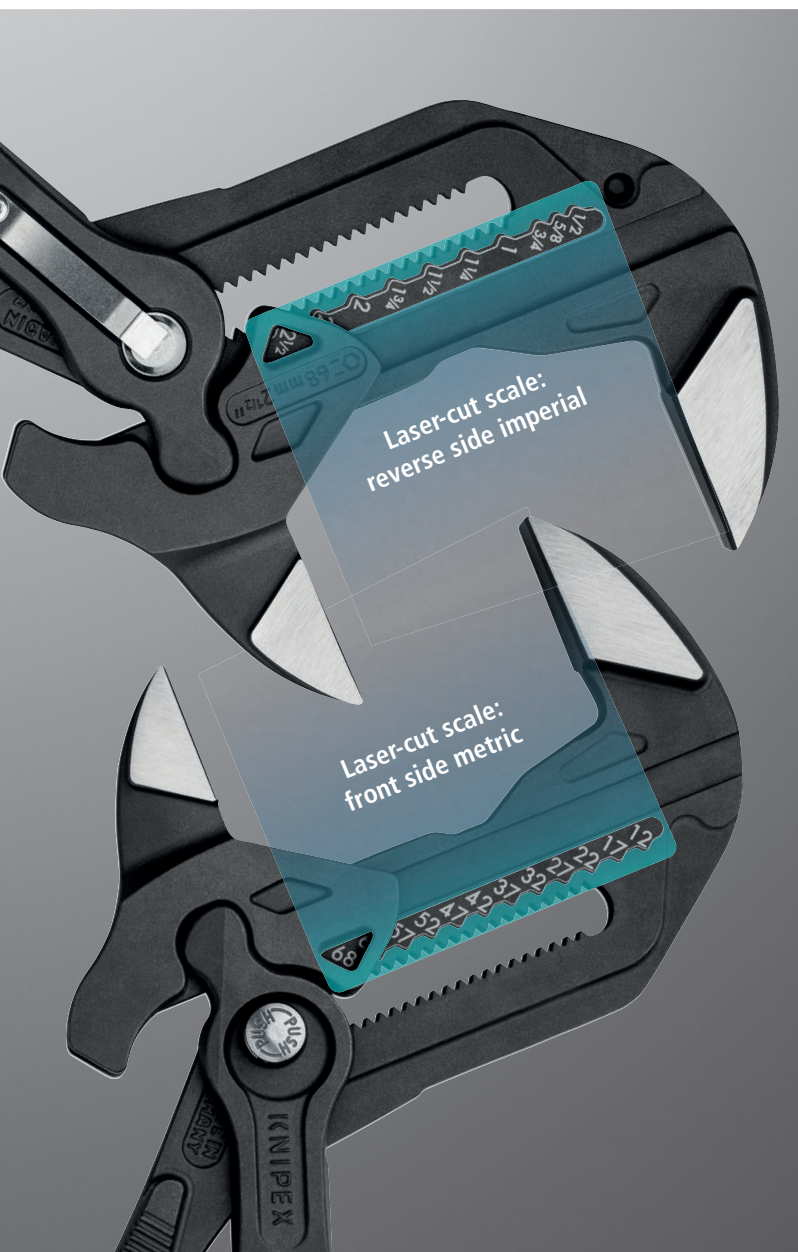

**Faster, easier and more precise: cuts copper, brass and stainless steel pipes**

**QuickLock one-hand locking mechanism: slide on, cut – finished!**

**Easy one-handed pushing for quick adjustment to different tube sizes**

**Comfortable: easy cutting due to high-quality needle bearings in the cutting wheel and guide rolls**

- > Cuts pipes from Ø 6 - 35 mm (1/4" - 1 3/8") with wall thickness up to 2 mm
- > Cutting wheel made of high-grade ball-bearing steel
- > Practical quick replace system for the cutting wheel – with spare wheel stored under the feeding barrel
- > With precision-ground deburring tool, easy to remove
- > For the electric trade: Also suitable to cut rigid steel conduits
- > Light and durable metal enclosure of magnesium



For cutting copper, brass and stainless steel pipes with wall thickness up to 2 mm and diameters of 6-35 mm (1/4" - 1 3/8")



← The overall length does not change during operation →



90 31 02

**NEW**  
PAT. PEND.



The needle-bearing and spring-loaded cutting wheel made of high-quality ball bearing steel is easily exchangeable



The spring-loaded cutting wheel can be pushed and fixed on the diameter of the pipe with the one-hand locking mechanism



Speed in everyday operation: the QuickLock one-hand locking mechanism enables the cutting wheel to slide onto any pipe diameter with a single press of the thumb



High-quality needle bearings enable the cutting wheel and the four guide rollers to operate virtually without any friction during the cutting – cuts stainless steel pipes with particular ease

**Four steps to success – how the KNIPEX TubiX® pipe cutter helps you in your work**



1 Cutting now made easy: position the opened KNIPEX TubiX® ...

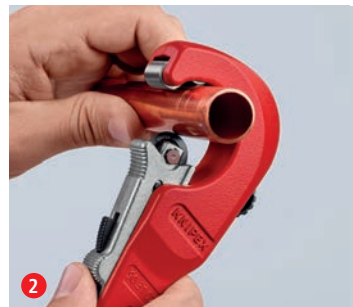

2 Push the cutting wheel against the pipe with the QuickLock one-hand locking mechanism: fastest adjustment to different pipe diameters ...



3 Tighten and cut with a swift twist and then readjust using the ergonomic blue feeding barrel ...



4 And you're done! If necessary, have the edge smoothed out using the fold-out deburring tool – with surprisingly little effort

Artikel-Nr.	EAN	↔	Ø mm	Ø Inch	g
90 31 02 SB	N 084686	180	6 - 35	1/4" - 1 3/8"	375
90 31 02 BK	N 084907	180	6 - 35	1/4" - 1 3/8"	375
90 39 02 V01	N 085874	Cutting wheel INOX Cu for 90 31 02			8
90 39 02 V02	N 085881	Deburring tool for 90 31 02			7
90 39 02 V03	N 086307	5x Cutting wheel INOX Cu for 90 31 02			25

**Tiny titan with 25-fold leveraging of hand strength –  
just right for round material**

Heavy-duty cutting edge with recess slices through the hardest round materials in only one cutting action

Extremely high cutting performance in a convenient length of 160 mm

Small, slim head for excellent accessibility

- > Compact and powerful: cuts bolts, nails, rivets etc. up to Ø 4.8 mm
- > Cutting edge hardness approx. 64 HRC
- > Less physical effort due to efficient lever action mechanism
- > Slippage of cutting material reduced by lasered cutting edge
- > With gripping surface below the joint for gripping and pulling wires from Ø 1.0 mm
- > Blades with recess for easier cutting of larger cross-sections thanks to better leverage close to the fulcrum
- > Chrome vanadium heavy-duty steel, forged, multi stage oil-hardened

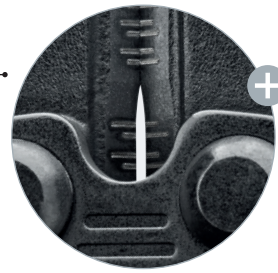

**NEW**

With recess in the cutting edge



71 31 160

**Ideal for round materials:  
the KNIPEX CoBolt® with recess**

The recess enables round materials to be placed closer to the joint when cutting. The improved leverage makes easy work of cutting through even very hard materials with less effort.

Available in lengths of  
160 mm – item no. 71 31 160  
200 mm – item no. 71 31 200  
250 mm – item no. 71 31 250



**Ideal for flat materials:  
the KNIPEX CoBolt® without recess**

The cutting edge without the recess provides optimum cutting for flat materials. The lasered cutting edge also keeps the cutting material from slipping.

Available in lengths of  
160 mm – item no. 71 01 160  
200 mm – item no. 71 01 200  
250 mm – item no. 71 01 250



Article No.	EAN 4003773-	↔ mm	Pliers	Handles	Cutting capacities				⚖ g
					Ø mm	Ø mm	Ø mm	Ø mm	
71 31 160	084587	160	grey atramentized	plastic coated	5,3	4,8	3,6	3,3	195
71 31 160 SB	085850	160	grey atramentized	plastic coated	5,3	4,8	3,6	3,3	195

## Pipe Cutter for plastic composite pipes

90

**Clean cut: cuts aluminium composite and plastic pipes with great precision**

For cutting composite pipes from Ø 12 - 25 mm

Clean, smooth and burr-free cut surfaces

Easily exchangeable blades

- > With opening spring and locking device
- > Ergonomically shaped handles made of fibreglass-reinforced plastic
- > Not suitable for cutting cables
- > Blade made of high-strength special grade steel, oil-hardened and tempered



Article No.	EAN 4003773-	↔ mm	Cutting capacities Ø mm	⚖ g
90 25 185	084839	185	12 - 25	175
90 25 185 SB	086093	185	12 - 25	175
90 29 01	031932	Spare blade		24

**NEW**



90 25 185



The high-strength, sharp blade cuts composite and plastic pipes smoothly and free of burr

## Pipe Cutter for multilayer and pneumatic hoses

90

**Perfect cutting results: the hose and pipe cutter for professional users**

Ideal for all liquid, multilayer and pneumatic hoses/pipes commonly available on the market in the wide application range from Ø 4 - 20 mm

With universal support for right-angled positioning

Easy on the hands even in continuous use thanks to low force required and automatic opening thanks to the spring mechanism

- > Easily exchangeable blades
- > With opening spring and locking device
- > Ergonomically shaped handles made of fibreglass-reinforced plastic
- > Not suitable for cutting cables
- > Blade made of high-strength special grade steel, oil-hardened and tempered



Article No.	EAN 4003773-	↔ mm	Cutting capacities Ø mm	⚖ g
90 10 185	084846	185	4 - 20	175
90 10 185 SB	086086	185	4 - 20	175
90 29 01	031932	Spare blade		24

**NEW**

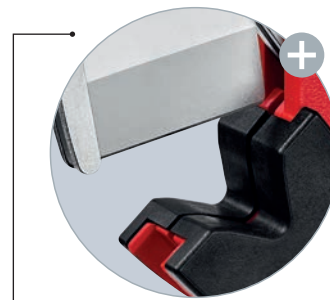

The wide support lips automatically align pipes perfectly at right angles to the blade



90 10 185



Thanks to the ergonomic handles, smooth joint and the opening spring, you can cut flexible pipes or pneumatic hoses with little effort



# KNIPEX X-Cut® Compact Diagonal Cutter

73

Powerful, light and universal

Cuts finest strands as well as multi-core cables and piano wires

- > Box-joint design: highest stability with low weight
- > Doubly supported joint axis for heaviest duty
- > High cutting performance with minimum effort due to optimum coordination of the cutting edge angle and transmission ratio
- > 40% less force required compared with standard diagonal cutters of the same length
- > Large opening width for thicker cables
- > Cuts precisely, even through fine copper wires
- > Compact, low-weight construction
- > Universally usable, in the assembly, maintenance and production
- > Chrome vanadium heavy-duty steel, forged, multi stage oil-hardened



1000 V



73 06 160

PATENTED



73 02 160



73 05 160

Article No.	EAN 4003773-	Ø mm	Ø mm	Ø mm	Ø mm	Ø mm	Ø mm	mm
73 02 160	075127	4.8	3.8	2.7	2.2	12.0	160	
73 05 160	075134	4.8	3.8	2.7	2.2	12.0	160	
73 06 160	075141	4.8	3.8	2.7	2.2	12.0	160	
73 06 160 T	081487	4.8	3.8	2.7	2.2	12.0	160	



40% less force required  
compared with standard diagonal  
cutters of the same length

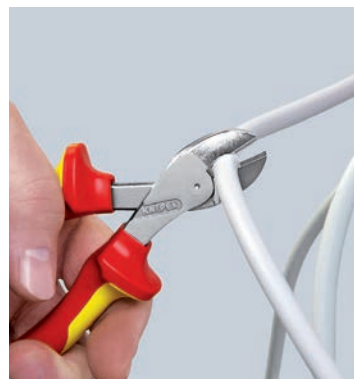
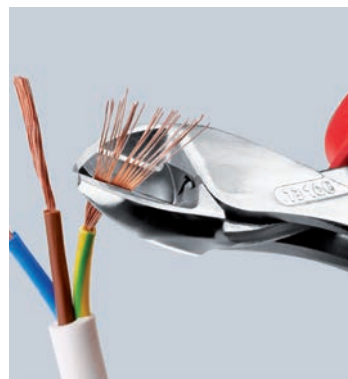

## Diagonal Cutters

70

- > The indispensable diagonal cutter for all-round use
- > High-quality material and precise workmanship for long service life
- > Precision cutting edges for soft and hard wire
- > Clean cutting of thin copper wires, also at the cutting-edge tips
- > Cutting edges additionally induction hardened, cutting edge hardness approx. 62 HRC
- > Narrow head style for use in confined areas
- > Vanadium electric steel, forged, multi stage oil-hardened



Precision rivet:  
new and more stable rivet shape



70 06 160

Article No.	EAN					
	4003773-		Ø mm	Ø mm	Ø mm	mm
70 06 125	018124		3.0	2.3	1.5	125
70 06 140	040293		4.0	2.5	1.8	140
70 06 160	021995		4.0	3.0	2.0	160
70 06 160 T	081463		4.0	3.0	2.0	160
70 06 180	033813		4.0	3.0	2.5	180
70 06 180 T	081470		4.0	3.0	2.5	180



1000 V



Cuts thin Cu wire accurately...

... also at the cutting edge tips



## High Leverage Diagonal Cutters

74

- > With integrated forged axle for heaviest duty
- > Suitable for all types of wire including piano wire
- > High cutting performance with minimum effort due to optimum coordination of the cutting edge angle and transmission ratio

### Length 250 mm

- > The 250-mm-long diagonal cutter is suitable for copper conductors of up to 16 mm<sup>2</sup> and aluminium conductors up to 35 mm<sup>2</sup>.



74 06 200



Article No.	EAN					
	4003773-		Ø mm	Ø mm	Ø mm	mm
74 06 160	040705		3.4	2.5	2.0	160
74 06 180	022985		3.8	2.7	2.2	180
74 06 200	033820		4.2	3.0	2.5	200
74 06 200 T	081494		4.2	3.0	2.5	200
74 06 250	041955		4.6	3.5	3.0	250
74 06 250 T	081500		4.6	3.5	3.0	250

## Magnetic LED Lamp

00

- > For illuminating dark working areas
- > Attachment to tool by means of strong magnets
- > Very compact dimensions
- > Approx. 24 hours of lighting, with 2 replaceable button cells (CR1220)
- > Snap-hook fastening
- > Impact-resistant plastic housing

Article No.	EAN
00 11 V50	075387

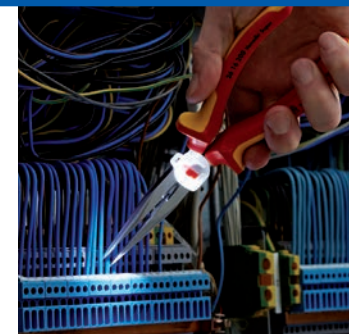
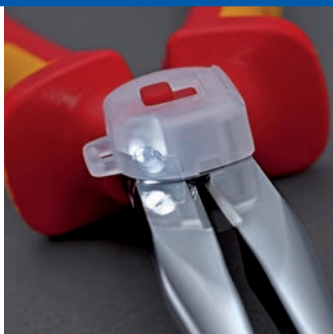

# Pliers for Electrical Installation

The mobile task force

13

Multifunctional pliers for the electrical installation; to grip flat and round material, for bending, deburring, cutting cable, stripping and crimping wire ferrules

## 6 functions in one pair of pliers

- > Smooth surfaces near the tips grip single cores without damaging them; serrated gripping surfaces and pipe grip for gripping flat and round material
- > Clear-cut outside edge on the jaw for working on flush-mounted junction boxes and deburring feed-through holes
- > Stripping holes for conductors of 0.75 – 1.5 mm<sup>2</sup> and 2.5 mm<sup>2</sup>
- > Crimp die for wire ferrules 0.5 – 2.5 mm<sup>2</sup>
- > Cable shears with (induction-hardened) precision cutting edges for copper and aluminium cables up to 5 x 2.5 mm<sup>2</sup>/Ø 15 mm
- > Gripping, without opening the pliers completely (intelligent latching mechanism in the spring assisted version). The cutting edge remains closed and protected
- > Slim dimensions for easy access
- > Bolted joint: precise, zero backlash operation of pliers

PATENTED

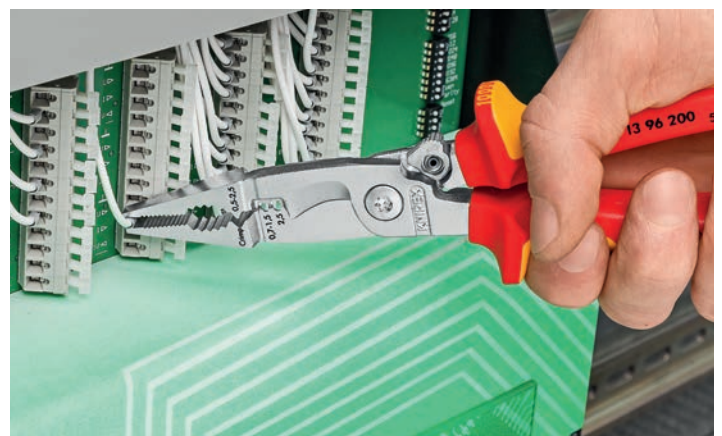
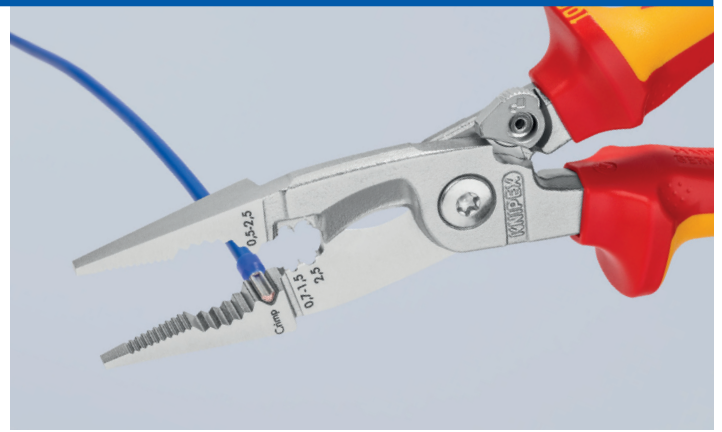

13 86 200



13 96 200  
MM



13 82 200



13 92 200  
MM

Article No.	EAN 4003773-	Safety icons	Handles	Cutting capacity		
				Ø mm	mm <sup>2</sup>	mm
13 82 200	075080		with multi-component grips	15	50	200
13 86 200	075097	⚡ 1000V	insulated with multi-component grips, VDE-tested	15	50	200
13 92 200	075103	MM	with multi-component grips	15	50	200
13 96 200	075110	MM ⚡ 1000V	insulated with multi-component grips, VDE-tested	15	50	200
13 96 200 T	081425	MM ⚡ 1000V	insulated with multi-component grips, VDE-tested	15	50	200



13 92 200 / 13 96 200

The intelligent latching mechanism enables you to "grip" without opening the pliers. The cutting edge remains closed and protected.

## Electricians' Pliers

13  
0

- > The ideal pliers for cable work
- > For gripping and bending wire
- > For cutting medium-hard and hard wire
- > Precision cutting edges additionally induction hardened, cutting edge hardness approx. 60 HRC
- > With precision stripping holes
- > For crimping wire ferrules
- > Crimping 0.5 to 2.5 mm<sup>2</sup>

Article No.	EAN 4003773-		Stripping capacities Ø mm <sup>2</sup>	Ø mm	Ø mm	↔ mm
13 01 160	034971		0.5 - 0.75 / 1.5 / 2.5	2.5	1.6	160
13 02 160	010470		0.5 - 0.75 / 1.5 / 2.5	2.5	1.6	160

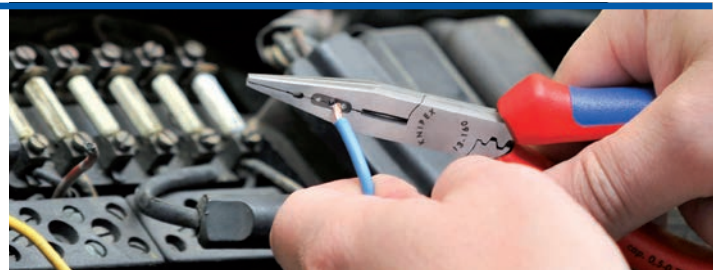

## Stripping Pliers

13

**Multifunctional - cutting and stripping with one pair of pliers**

For time-saving stripping of all round sheathed and damp-proof installation cables (e.g. NYM cable)

Simplified access especially into deep mounted junction boxes thanks to slim head design and optimally angled cable sheath cutter

Strip cables easily and without damage thanks to circular cutting edge with depth limiter

- > Suitable for universal use: precision wire stripping holes for conductors from 1.5 and 2.5 mm<sup>2</sup>
- > With side cutters for cutting and trimming conductors, wires, small screws and nails
- > All cutters additionally induction hardened to approx. 61 HRC for high wear resistance
- > 30 % lighter than comparable pliers
- > Vanadium electric steel, forged, multi stage oil-hardened



Circular cutting edge with depth limiter: for easy stripping without damage to inner cables

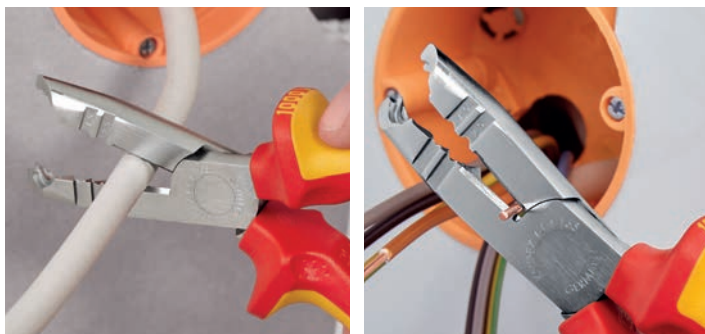

Article No.	EAN 4003773-		Pliers	Head	Handles	Cable stripping values Ø mm	Stripping capacities Ø mm <sup>2</sup>	Ø mm	Ø mm	↔ mm
13 46 165	079699	1000 V	chrome plated		insulated with multi-component grips, VDE-tested	8 - 13	0,75 - 1,5 mm <sup>2</sup> / 2,5 mm <sup>2</sup>	3.2	2.2	165

**Insulation strippers with cable shears – two essential electrical installation tools in one pair of pliers**

- > For single, multiple and fine stranded conductors with plastic or rubber insulation up to Ø 5 mm or 10 mm<sup>2</sup> cross-section
- > Graduated jaw provides a visual orientation aid when stripping wire in standard lengths (11 mm and 16 mm)
- > Easy adjustment to the required diameter of solid or stranded wire with knurled screw and lock nut
- > Shear blade for cutting copper and aluminium cable of up to Ø 15 mm (5 x 2.5 mm<sup>2</sup>)
- > Slim dimensions for easy access
- > Bolted joint: precise, zero backlash operation of pliers
- > High-grade special tool steel, forged, multi stage oil-hardened

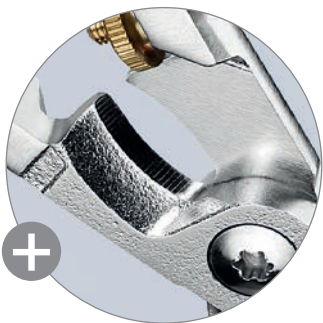

Induction hardened precision blade



13 66 180

(PAT. PEND.)

**KNIPEX StriX®**



Induction hardened shear blade with precisely ground cutting edges for crushing-free cutting of copper cables of up to Ø 15 mm (5 x 2.5 mm<sup>2</sup>)

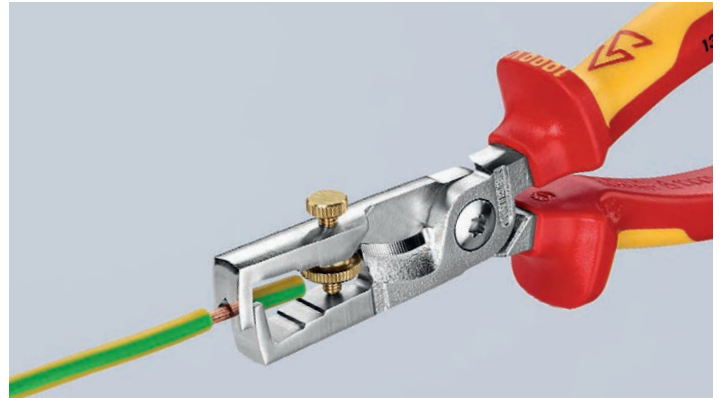

Lock nut prevents any unintentional adjustment

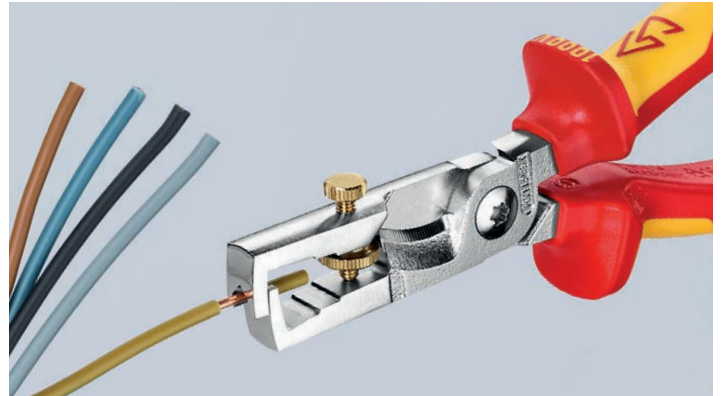

Length marking: visual markings provide support during repeated stripping of wire in standard lengths (11 and 16 mm)



Article No.	EAN	Safety	Pliers	Head	Handles	Cutting capacity		Stripping capacities		↕ mm
						Ø mm	mm <sup>2</sup>	Ø mm	mm <sup>2</sup>	
13 62 180	081302		black atramentized	polished	with multi-component grips	15	50	5	10	180
13 66 180	081319	⚡ 1000 V	chrome plated	polished	insulated with multi-component grips, VDE-tested	15	50	5	10	180
13 66 180 T	081906	⚡ 1000 V	chrome plated	polished	insulated with multi-component grips, VDE-tested	15	50	5	10	180

## Insulation Strippers

11

- > For single, multiple and fine stranded conductors with plastic or rubber insulation up to  $\varnothing$  5 mm or 10 mm<sup>2</sup> cross-section
- > Easy adjustment to the required diameter of solid or stranded wire with knurled screw and lock nut
- > Special tool steel, forged, oil-hardened



11 06 160

Article No.	EAN 4003773-		Stripping capacities			↔ mm
			Ø mm	mm <sup>2</sup>	AWG	
11 06 160	021933		5.0	10	8	160
11 06 160 T	081418		5.0	10	8	160

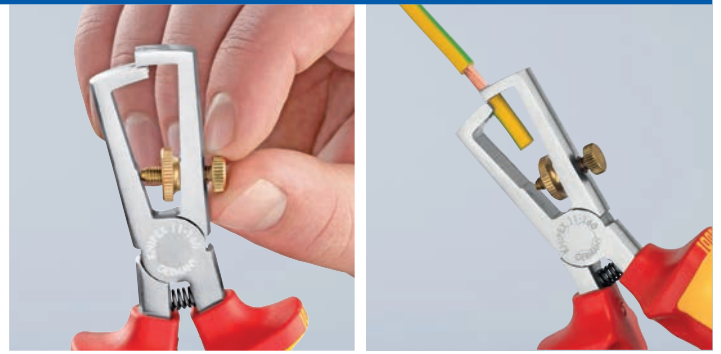

## Diagonal Insulation Stripper

14

With long cutter

High cutting capacity due to high leverage joint

- > Precision stripping holes for single (solid) conductors of 1.5 and 2.5 mm<sup>2</sup>
- > Convenient cutting of NYM cables of up to 5 x 2.5 mm<sup>2</sup>
- > Long tips for ultra fine cutting work also in confined areas
- > Induction hardened precision blades for soft wire of up to  $\varnothing$  4 mm., cutting edge hardness approx. 60 HRC

Article No.	EAN 4003773-		Stripping capacities mm <sup>2</sup>	AWG	Ø mm		↔ mm
14 26 160	040279		1.5 + 2.5	16 / 14	2.5	1.5	160

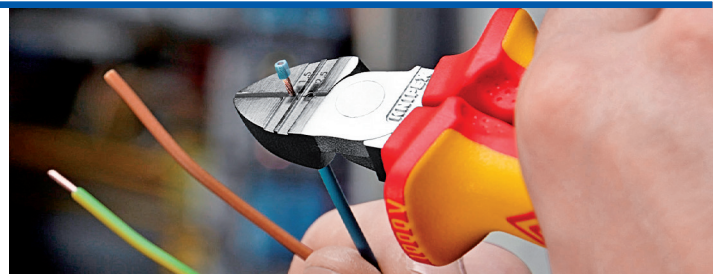

## Snipe Nose Side Cutting Pliers

26

- > Suitable for finer gripping and cutting work
- > Half-round, long, pointed jaws
- > Knurled gripping surfaces
- > With cutting edges for soft, medium-hard and hard wire
- > Cutting edges additionally induction hardened, cutting edge hardness approx. 61 HRC
- > Vanadium electric steel, forged, multi stage oil-hardened



Article No.	EAN 4003773-				Ø mm		↔ mm
25 06 160	033806				2.5	1.6	160
25 06 160 T	081432				2.5	1.6	160
25 26 160	052111		$\angle 40^\circ$		2.5	1.6	160
26 16 200	022831				3.2	2.2	200
26 16 200 T	081449				3.2	2.2	200
26 26 200	022855		$\angle 40^\circ$		3.2	2.2	200
26 26 200 T	081456		$\angle 40^\circ$		3.2	2.2	200

## Needle-Nose Combination Pliers

08

Small High Leverage Combination Pliers with pointed jaw.  
For all common installation and repair work.

Handy use when working in confined areas thanks to slim head design and pointed jaws (anti-twist)

Gripping surfaces with special convex contour on one side for secure gripping of flat parts

Milled groove in the gripping area permits small parts such as nails, pins and bolts to be held and pulled

- > The reliable and diverse combination pliers when out and about
- > Easy cutting thanks to the high leverage joint
- > With cutting edges for soft, medium-hard and hard wire
- > Long service life and stable tips
- > Forged from special high grade tool steel, manifold oil-hardened



Milled groove in the gripping area



Firm grip also on flat material due to three-point rest



08 26 145

Article No.	EAN 4003773-	Icons	Pliers	Head	Handles	Cutting capacity				↔ mm
						Ø mm	Ø mm	Ø mm	mm <sup>2</sup>	
08 21 145	078951		black atramentized	polished	plastic coated	3.0	2.0	8.0	16.0	145
08 22 145	078968		black atramentized	polished	with multi-component grips	3.0	2.0	8.0	16.0	145
08 25 145	078975		chrome plated		with multi-component grips	3.0	2.0	8.0	16.0	145
08 26 145	079361		chrome plated		insulated with multi-component grips, VDE-tested	3.0	2.0	8.0	16.0	145
08 26 145 T	081401		chrome plated		insulated with multi-component grips, VDE-tested	3.0	2.0	8.0	16.0	145

## Combination Pliers

03

> With gripping zones for flat and round material, suitable for versatile use

> With cutting edges for soft and hard wire

> Long cutting edges for thicker cables

> Cutting edges additionally induction hardened, cutting edge hardness approx. 60 HRC

> Special tool steel, forged, multi stage oil-hardened



Article No.	EAN 4003773-	Icons	Ø mm	Ø mm	Ø mm	mm <sup>2</sup>	↔ mm
			3.1	2.0	10.0	16.0	160
03 06 160	021902		3.1	2.0	10.0	16.0	160
03 06 180	021926		3.4	2.2	12.0	16.0	180
03 06 200	033776		3.8	2.5	13.0	16.0	200
03 06 180 T	081395		3.4	2.2	12.0	16.0	180



03 06 180

## Long Nose Pliers

30

- > Heavy-duty and hard-wearing gripping pliers
- > Different jaw styles
- > Chrome vanadium electric steel, forged, oil-hardened

Article No.	EAN 4003773-			↔ mm
<b>30 16 160</b>	001904	⚡ 1000 V	long, trapezoidal jaws, knurled gripping surfaces	160
<b>30 36 160</b>	002123	⚡ 1000 V	long, round jaws, smooth gripping surfaces	160



## Flat Nose Pliers

made of plastic

98  
6

- > Fully insulating to reduce risk of short circuit
- > For meter assembly and meter blocking
- > Class C; range of use up to -40°C
- > Plastic material, fibreglass-reinforced
- > Handles with soft plastic zone for better grip

Article No.	EAN 4003773-		↔ mm
<b>98 62 01</b>	073956	⚡ 1000 V	180
<b>98 62 02</b>	073963	⚡ 1000 V	220



## KNIPLEX Cobra®

Hightech Water Pump Pliers, VDE-tested

87  
2

Adjustment by shifting one jaw directly on to the workpiece: fast, reliable and comfortable handling

Opening at the touch of a button apart from the workpiece

- > Self-locking on pipes and nuts: no slipping on the workpiece and low handforce required
- > Fine adjustment for optimum adaptation to different sizes of workpieces and a comfortable handle width
- > Chrome vanadium electric steel, forged, multi stage oil-hardened



87 26 250

Article No.	EAN 4003773-		Adjustment positions	⊘ Inch	⊘ mm	⊘ mm	↔ mm
<b>87 26 250</b>	071495	⚡ 1000 V	24	2	50	46	250
<b>87 26 250 T</b>	081517	⚡	24	2	50	46	250



The adjustment action to adapt to the workpiece is easy and reliable with the KNIPLEX Cobra® VDE: place the upper gripping jaw of the opened pliers on the workpiece, push pliers to close, done!



## KNIPLEX Alligator®

Water Pump Pliers, VDE-tested

88

- > Good access to the workpiece due to slim size of head and joint area
- > Self-locking on pipes and nuts: no slipping on the workpiece and low handforce required
- > Chrome vanadium electric steel, forged, multi stage oil-hardened

Article No.	EAN 4003773-		Adjustment positions	⊘ Inch	⊘ mm	⊘ mm	↔ mm
<b>88 06 250</b>	039303	⚡ 1000 V	9	2	50	46	250





## Cable Shears

95

- > For cutting copper and aluminium single conductors as well as multiple stranded cables
- > Not suitable for steel wire and hard drawn copper conductors
- > Precision ground, hardened blades
- > Clean and smooth cut without crushing and deformation
- > Easy cutting with one-hand operation
- > Guard prevents operators' fingers being pinched
- > Adjustable bolted joint, self-retaining screw
- > High-grade special tool steel, forged, oil-hardened

### 95 26 165

- > Internal opening spring, protected and captive

### 95 41 165

- > Multifunctional tool for working on NYM cable from 3 x 1.5 mm<sup>2</sup> to 5 x 2.5 mm<sup>2</sup> (cutting and stripping)



Article No.	EAN 4003773-		Ø mm	mm <sup>2</sup>	AWG	↔ mm
95 11 165	040323		15	50	1/0	165
95 12 165	029182		15	50	1/0	165
95 16 165	039648	⚡ 1000 V	15	50	1/0	165
95 16 165 T	081524	⚡ 1000 V	15	50	1/0	165
95 26 165	069980	⚡ 1000 V	15	50	1/0	165
95 41 165	078609	⚡	12	35	1/0	165



95 16 165

## Cable Shears with twin cutting edge

95

- > For cutting copper and aluminium cables
- > Not suitable for steel wire and hard drawn copper conductors
- > Precision ground, hardened blades
- > Clean and smooth cut without crushing and deformation
- > Easy cutting with one-hand operation
- > Initial and final cut (upper and lower blade) allows cables of up to Ø 20 mm to be cut
- > Low handforce required due to favourable lever ratio and special blade geometry
- > Guard prevents operators' fingers being pinched
- > Adjustable bolted joint, self-retaining screw
- > High-grade special tool steel, forged, oil-hardened



95 16 200

Article No.	EAN 4003773-		Ø mm	mm <sup>2</sup>	AWG	↔ mm
95 12 200	047834		20	70	2/0	200
95 16 200	026761	⚡ 1000 V	20	70	2/0	200



**Initial cut:** using the front cutting edge to cut the insulating sheath on larger cable diameters retains an ergonomic handle opening width.



**Final cut:** after cutting the sheath in the front profile the conductors in the rear part are cut. Initial cut in the front profile, final cut in the rear profile - to keep it as easy as possible.

## Cable Cutters (ratchet action)

95  
3









- > For cutting copper and aluminium single conductors as well as multiple stranded cables
- > Not suitable for steel wire and wire ropes
- > Precision ground, hardened blades
- > Clean and smooth cut without crushing and deformation
- > One-hand operation using ratchet principle
- > Little handforce required due to very high transmission ratio
- > Two-stage ratchet drive for easy cutting
- > Simple handling as a result of low weight and compact design – can be used even in confined areas
- > Guard prevents operators' fingers being pinched
- > High-grade special tool steel, forged, oil-hardened



95 36 280



95 36 250

Article No.	EAN 4003773-		 Ø mm	 mm <sup>2</sup>	MCM	 mm
95 36 250	026884	  1000 V 	32	240	500	250
95 36 280	026891	  1000 V 	52	380	750	280

## Cable Cutters (ratchet principle)

95  
3







**Sturdy. Easy to use. Stable**  
**Innovative ratchet-drive**  
**For cable up to 60 mm diameter**

- > Easy handling due to low weight (825 g) and compact construction (320 mm length) – also usable in confined areas
- > Cutting through copper and aluminium cables with diameters of up to 60 mm in one-hand and two-hand operation
- > Hardened cutting edges, precisely ground, cut smoothly and neatly without crushing
- > For cutting copper and aluminium single conductors as well as multiple stranded cables (not suitable for steel wire and wire ropes)
- > Innovative three-stage ratchet-drive with high leverage for easy cutting in one-hand and two-hand operation
- > Innovative high leverage three-stage ratchet-drive
- > Fixed handle with support area for putting down the pliers when cutting
- > High-grade special tool steel, forged, oil-hardened



95 36 320

PAT. PEND.

Article No.	EAN 4003773-		 Ø mm	 mm <sup>2</sup>	MCM	 mm
95 32 320	075172		60	600	1200	320
95 36 320	075189	  1000 V 	60	600	1200	320

## Cable Cutters (ratchet action) for steel wire armoured cables (SWA cable)

95  
3

Cuts through steel wire armoured cables with a diameter of up to 45 mm / 380 mm<sup>2</sup> (e.g. 4 x 95 mm<sup>2</sup>) using one or two-handed operation

- > Simple handling due to low weight (800 g) and compact design (315 mm length) – can also be used in confined areas
- > Precision ground blades and induction hardened cutting edges cut smoothly and neatly without crushing
- > Innovative high leverage three-stage ratchet-drive
- > Support area for putting down the pliers when cutting
- > Not suitable for cutting ACSR cable and wire rope!
- > High-grade special tool steel, forged, multi stage oil-hardened



95 36 315 A

PAT. PEND.

Article No.	EAN 4003773-		mm	mm <sup>2</sup>	MCM	mm
95 32 315 A	078562	MM	45	380	750	315
95 36 315 A	078579	1000 V	45	380	750	315

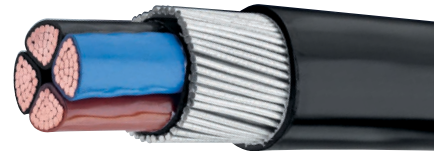

## ACSR Cable Cutter (ratchet action)

95

For cables with a steel core

Handy. Compact. Sturdy.  
Extremely robust design

- > Cuts through aluminium conductor cable with steel core up to a diameter of 32 mm in one or two-handed operation
- > Cutters with precision cut and induction hardened cutting edge
- > Two-stage ratchet drive for easy cutting
- > Less physical effort due to very high transmission ratio
- > Fixed handle with support area for putting down the pliers when cutting
- > Locking mechanism for transporting with safely closed handles
- > Special high grade tool steel, multi stage oil-hardened

Steel core

Conductor

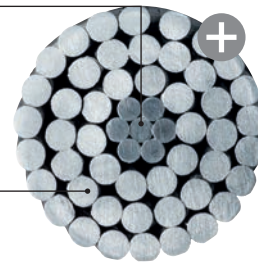

The outer area of these conductor cables consists of light, highly conductive aluminium wires, while the core is made of specially stretch-resistant, galvanised steel wires



PAT. PEND.

Article No.	EAN 4003773-		mm	MCM	mm
95 32 340 SR	081241		32	477	340





## Cable Shears

95  
1

Short design, length only 500 mm

Low weight, high leverage

- > For cutting copper and aluminium single conductors as well as multiple stranded cables
- > Not suitable for steel wire and wire ropes
- > Precision ground, hardened blades
- > Clean and smooth cut without crushing and deformation
- > Low handforce required due to favourable lever ratio and special blade geometry
- > Guard prevents operators' fingers being pinched
- > Adjustable bolted joint
- > Cutter head: vanadium electric steel, forged, oil-hardened
- > Handles: aluminium tube, high-strength

Article No.	EAN 4003773-	 Ø mm	 mm <sup>2</sup>	AWG	 mm
<b>95 12 500</b>	069966	27	150	6/0	500





## Cable Shears (ratchet action)

with telescopic handles

95  
3

- > For cable diameters of up to 38 mm, handles can be positioned at an angle to set the optimum handle width, which makes the shear also suitable for work in confined areas
- > Comfortable work thanks to ratchet action and low weight
- > Heavy duty telescopic handles made of oval aluminium tubing; extendable up to 770 mm for maximum leverage on large cable diameters; retractable down to 570 mm for minimum space requirements during transport
- > Replaceable cutting head
- > Extensive cutting range up to max. Ø 38 mm or max. 280 mm<sup>2</sup> (e.g. 4 x 70 mm<sup>2</sup> NYY) in copper and aluminium cables
- > Easier, neater cut due to optimised cutting-edge geometry
- > Adjustable bolted joint
- > Cutting head: special quality high grade tool steel, oil-hardened
- > Handles: high-strength oval aluminium tubing



Article No.	EAN 4003773-	 Ø mm	 mm <sup>2</sup>	MCM	 mm
<b>95 32 038</b>	071556	38	280	550	570 – 770



## Electronic Super Knips®

DIN ISO 9654

78

- > Precision pliers for ultra fine cutting work, e. g. in electronics and fine mechanics
- > Ground, very sharp cutting edges without bevel
- > Shear cut with controlled micro cutting edge misalignment for the most precise cutting of even the thinnest of wires and for a long service life
- > Precision shaped tips cut wires resting on a board from Ø 0.2 mm
- > Joint with stainless steel rivet
- > Extremely smooth movement for minimum operator fatigue
- > With opening spring and opening limiter

### 78 03 125

- > Cutting edge hardness approx. 54 HRC; INOX – stainless steel

### 78 61 125

- > Also suitable for cutting glass fibre cables (fibre optics)
- > Cutting edges additionally induction hardened, cutting edge hardness approx. 64 HRC
- > Special tool steel, oil-hardened in multiple stages

### Super Knips® XL

#### 78 03 140

- > Durable and stainless, made from INOX – stainless steel, cutting edges hardened to 54 HRC

#### 78 61 140

- > Heavy duty, made from burnished special tool steel, cutting edges additionally induction hardened to 64 HRC

Article No.	EAN 4003773-		Ø mm	Ø mm	↔ mm
78 03 125	035381	✳️ 🔴 🔴 🔴	0.2 - 1.6	1.0	125
78 06 125 	084099	✳️ 🔴 🔴 🔴 ⚡ 1000V	0.2 - 1.6	1.0	125
78 61 125	035404	✳️ 🔴 🔴 🔴	0.2 - 1.6	1.2	125
78 03 140	081647	✳️ 🔴 🔴 🔴	0.2 - 2.1	1.2	140
78 61 140	081685	✳️ 🔴 🔴 🔴	0.2 - 2.1	1.4	140

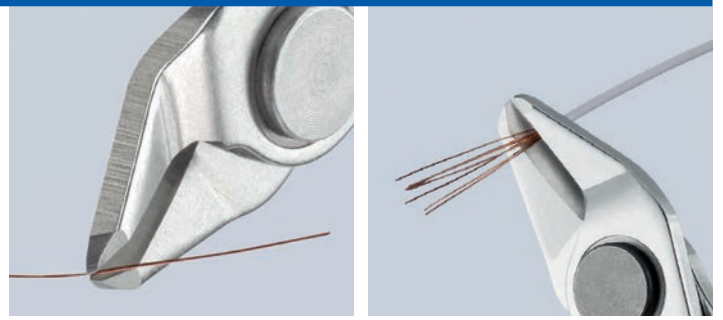

available in 140 mm length

## Precision Electronics Diagonal Cutters

DIN ISO 5654

79

- > Precision pliers for ultra fine cutting work, e. g. in electronics and fine mechanics
- > Very precisely ground and sharp cutting edges with very small bevels for exact cutting on delicate electronic components; also available without bevel for flush cutting
- > Cutting edges additionally induction hardened, cutting edge hardness approx. 64 HRC
- > Approx. 20% lighter than conventional electronics pliers
- > Bolted joint with carefully manufactured joint surfaces for even, low-friction movement throughout the entire opening range
- > Smooth-running double spring for a gentle and even opening
- > Ball bearing chrome steel, forged, multi stage oil-hardened

### 79 02 125

- > Round head

### 79 12 125

- > Specially for cutting through hard wire and piano wire

### 79 42 125

- > Pointed head

### 79 42 125 Z

- > For an optimised flush cutting result of soft materials



Article No.	EAN 4003773-		Ø mm	Ø mm	Ø mm	↔ mm
79 02 125	061403	✳️ 🔵 🔵 🔵 🔵	0.2 - 1.7	1.3	0.7	120
79 12 125	071365	✳️ 🔵 🔵 🔵 🔵	0.3 - 1.7	1.3	1.0	125
79 42 125	061380	✳️ 🔴 🔴 🔴 🔴	0.1 - 1.5	0.8		125
79 42 125 Z	078449	✳️ 🔴 🔴 🔴 🔴	0.1 - 1.3			125

## Electricians' Shears

95

Precisely ground blades with fine serration for a clean, non-slip cut  
Cutting edge with integrated cable cutter  
With plastic belt case

- > Universal shears for electricians
- > Handles with multi-component grips, fibreglass-reinforced
- > Cutting edges made from stainless steel, hardness of cutting edges 56 HRC



Article No.	EAN 4003773-	↔ mm
95 05 155 SB	077725	155

## Stripping Knives

Insulating multi-component handle, VDE-tested

98

5

- > Ergonomically designed handle shape with comfortable slip guard
- > Particularly confident grip thanks to slip-proof soft components
- > Thumb recess and "finger hook" at the end of the handle ensure a good transmission of force when the blade is pulled
- > Transparent protective cap

### 98 53 03

- > Solid, fixed hook blade
- > Suitable for round cables
- > Blade: special tool steel, oil-hardened

### 98 53 13

- > Narrow, fixed hook blade, sickle shaped
- > Suitable for sector cables
- > Blade: special tool steel, oil-hardened

### 98 55

- > Solid, fixed hook blade, sickle shaped
- > With guide shoe at the blade point
- > No damage of the conductor insulation
- > Blade: surgical steel, stainless, vacuum-hardened

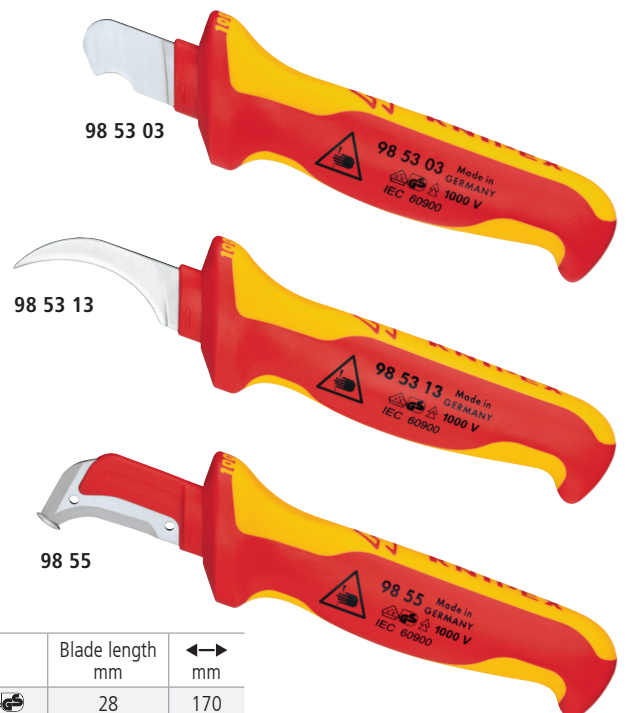

Article No.	EAN 4003773-		Blade length mm	↔ mm
98 53 03	026549	⚠ 1000V	28	170
98 53 13	026556	⚠ 1000V	50	190
98 55	022558	⚠ 1000V	38	180

## Cable Knives

Insulating multi-component handle, VDE-tested

98

5

- > Ergonomically improved handle shape with comfortable slip guard
- > Particularly confident grip thanks to slip-proof soft components
- > Thumb recess and "finger hook" at the end of the handle ensure a good transmission of force when the blade is pulled
- > Solid, fixed straight blade
- > Transparent protective cap
- > Blade: special tool steel, oil-hardened

### 98 52

- > Back of the blade plastic coated to avoid short circuits

Article No.	EAN 4003773-		Blade length mm	↔ mm
98 52	035565	⚠ 1000V	50	190
98 54	026563	⚠ 1000V	50	190



For the reliable and fast cutting of plastic corrugated pipes with the universal capacity range of diameters from 13 to 32 mm

No damage to the internal cables or pipes

- > Simple insertion, reliable and easy cutting without waste
- > Precise cut without damage thanks to unique arrangement of the cutters with side guide
- > Good accessibility thanks to slim design
- > Made of glass fibre reinforced multi-component plastic with soft gripping zone

**90 22 02 SB**

- > With wire stripping blades for cross-sections of 0.2/0.3/0.8/1.5/2.5/4.0 mm<sup>2</sup>
- > Location ridges (patent pending) on the 1.5 and 2.5 mm<sup>2</sup> wire stripping blades for the fast insertion of cable
- > Internal length scale for consistent stripping of cable, legible for both right and left handed users



Clean cutting edge with no damage to internal cables as the cut is always at the top of the corrugation

90 22 02 SB: Practical locator simplifies the insertion of single conductors for stripping



Also for protective pipes on aluminium composite pipes in plumbing, up to a diameter of 32 mm



Easy to use: press KNIPEX TwistCut® together, turn with slight pressure, done

Article No.	EAN 4003773-	Corrugated pipe cutting performance Ø mm	Stripping capacities mm <sup>2</sup>	↔ mm
<b>90 22 01 SB</b>	082286	13 - 32		100
<b>90 22 02 SB</b>	082293	13 - 32	0.2 - 4.0	100

**Electricians' Shears**

Universal shears with crimp area for electricians

With crimp function for wire ferrules

- > Precisely ground blades with fine serration for clean, non-slip (nonskid) cut
- > Crimp zone for crimping wire ferrules up to a diameter of 6.0 mm
- > With plastic belt pouch
- > Handles with multi-component grips, glass fibre reinforced
- > Cutting edges made from stainless steel, hardness of cutting edges 56 HRC

Article No.	EAN 4003773-	↔ mm
<b>95 05 10 SB</b>	082125	160

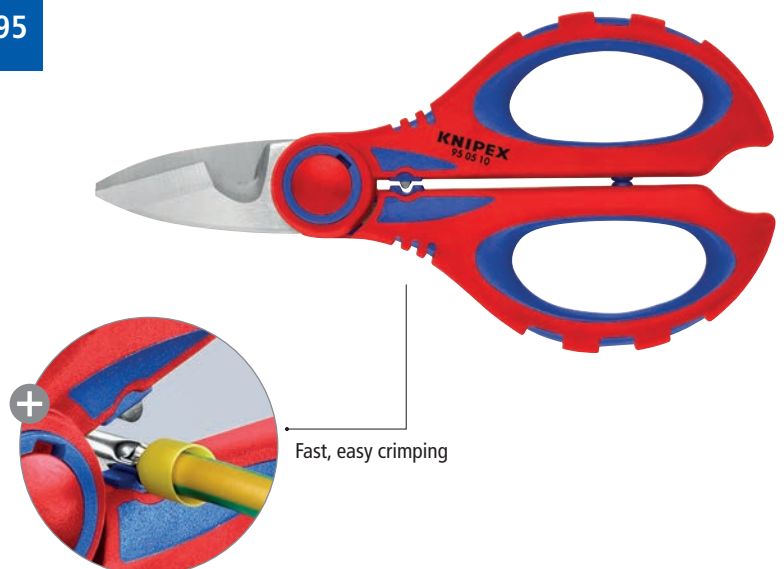

Fast, easy crimping

# KNIPEX ErgoStrip® Universal Stripping Tool

16  
95

For the fast and precise stripping of all common round and damp-proof installation cables (e.g. NYM cable 3 x 1.5 mm<sup>2</sup> up to 5 x 2.5 mm<sup>2</sup>), data cable (e.g. twisted pair) and coax cable

Innovative, ergonomic pistol grip design for easy cutting, stripping and longitudinal cut of the sheath

- > Conical, slimmed down tool ends for better access in confined areas
- > Stripping device for cross-sections 0.2/0.3/0.8/1.5/2.5/4 mm<sup>2</sup>
- > Simplified insertion of single wires for stripping using location ridges
- > With opening spring and locking device
- > Easy insertion of coax and data cable thanks to opening aid
- > Multi-component design with a soft plastic zone for comfortable use and a secure grip
- > Housing made from stable glass fibre reinforced plastic



With concealed cutter in overhanging thumb rest on the side for convenient lengthwise cut

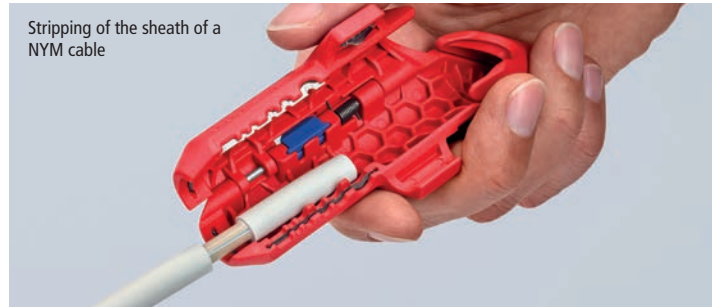

Stripping of the sheath of a NYM cable

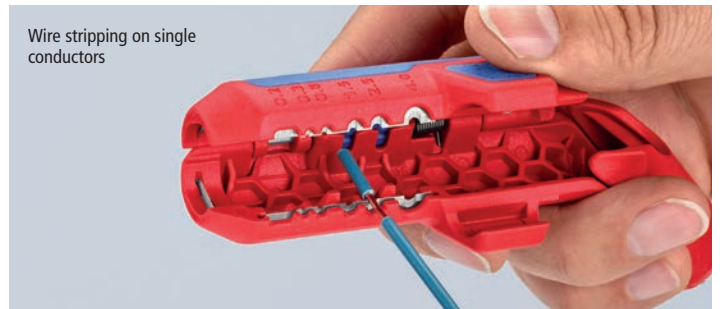

Wire stripping on single conductors



Stripping of the sheath of a coax cable



Stripping of the insulation of a coax cable



Stripping of the sheath of a data cable



16 95 01 SB  
PATENTED



16 95 02 SB  
PATENTED

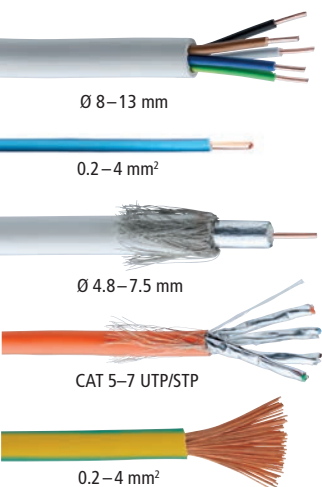

Article No.	EAN 4003773-	Stripping capacities				↔ mm
		round cable Ø mm	conductors and strands mm <sup>2</sup>	data cable	coax cable Ø mm	
16 95 01 SB	079927	8 - 13	0.2 - 4.0	CAT 5 - 7, Twisted-Pair (UTP/STP)	4.8 - 7.5	135
16 95 02 SB	082910	8 - 13	0.2 - 4.0	CAT 5 - 7, Twisted pair (UTP/STP)	4.8 - 7.5	135



## Automatic Stripping Pliers

for multicore cable Ø 4.4 to 7.5 mm  
with irregular sheathing cross-section

12  
74

For control and sensor cables / actuator cables, also for stripping flexible 3-core feed cables and extension cable

Automatic adjustment to cable diameters between 4.4 and 7.5 mm

No damage to the inner conductor or shield braid

- > For oil-resistant, halogen-free control and sensor/actuator cables with multicore cable design, shielded and unshielded
- > Suitable for highly flexible TPE-U-pipes, PUR and PVC cable sheathing, rubber leads such as H05 etc.
- > Long stripping lengths possible
- > Body: plastic, fibreglass-reinforced
- > Exchangeable blade: special tool steel, oil-hardened

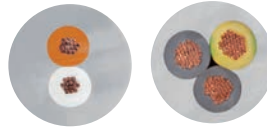

Sectional view of an extension lead

Article No.	EAN	Stripping capacities Ø mm	↔ mm
12 74 180 SB	082323	4.4 - 7.5	175
12 79 31	082682	1 pair of spare blades for 12 74 180 SB	



Required stripping length easy to read off



Complex cutter design for precise and damage-free stripping of round cables

## Folding Knife for Electricians

16  
20

Always to hand: the high-quality all-purpose cutter

Universal folding cutter for everyday use

Durable and robust: top quality, extremely sharp blade – Made in Solingen

- > Ergonomic handle shape for comfortable holding and easy guidance
- > Handle made from robust, shock-resistant plastic
- > Good power transmission during use
- > Stable blade
- > Tether attachment at the end of the cutter allows a fastener to be attached; also suitable for KNIPEX Tethered Tools
- > Blade made of stainless steel



Easy opening thanks to the practical diamond-shaped grip on the blade



The Electricians' Folding Cutter is quickly available to hand and is suitable for all the usual cutting tasks



For KNIPEX Tethered Tools: the tether attachment on the handle allows a fastener to be attached



16 20 50 SB

Made in  
**Solingen**

Article No.	EAN	⚖ g	↔ mm
16 20 50 SB	082705	85	Blade length 80 mm

## Stripping Tool

16  
30

Universal tool with adjustable cutting depth and three types of cut: round, lengthwise and spiral cut

- > For stripping round cable sheaths made of PVC, rubber, silicone or PTFE
- > Self-tightening holding lever
- > With knurled nut for cutting depth adjustment



16 30 135 SB



Article No.	EAN	Stripping capacities Ø mm	↔ mm
16 30 135 SB	4003773-033349	6.0 – 29.0	135
16 30 145 SB	081029	19.0 – 40.0	150

## Stripping Tool

16  
40

- > For stripping round cables exceeding Ø 25 mm.
- > Removes all sheaths of standard cables
- > Suitable for longitudinal and circular cutting
- > Tool body: plastic, fibreglass-reinforced



Article No.	EAN	Stripping capacities Ø mm	↔ mm
16 40 150	4003773-026709	> 25.0	150

## Stripping Tools

16  
20

- > For stripping all common round cables
- > Self-tightening holding lever
- > With adjusting screw for cutting depth adjustment
- > Turnable blade for circular and longitudinal cutting
- > Spare blade inside the handle

16 20 165 SB

- > With knife and hook blade, protective cap included



16 20 165 SB

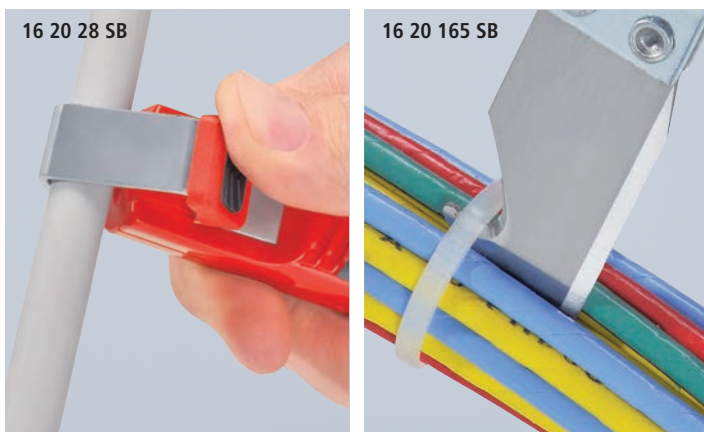

Article No.	EAN	Stripping capacities Ø mm	↔ mm
16 20 28 SB	4003773-060468	8.0 – 28.0	130
16 20 165 SB	043133	8.0 – 28.0	165

## Universal Stripping Tools

16

- > For stripping all common round and damp-proof installation cables between Ø 8.0 – 13.0 mm (e.g. 3 x 1.5 mm<sup>2</sup> up to 5 x 2.5 mm<sup>2</sup>)
- > Body: plastic, fibreglass-reinforced

16 85 125 SB

- > With additional blade for longitudinal cuts
- > Telescopic blade inside

16 90 130 SB

- > Specially suitable for larger cross-sections and for difficult insulating materials
- > For use in confined and difficult to access work areas
- > No adjustment of blades to cutting depth required
- > Stripping device for conductors and strands 1.5 mm<sup>2</sup> and 2.5 mm<sup>2</sup>



16 85 125 SB

16 90 130 SB

Article No.	EAN	Stripping capacities Ø mm	Types of cables	↔ mm
16 80 125 SB	4003773-040828	8.0 – 13.0	round cable, e.g.: 3 x 1.5 mm <sup>2</sup> up to 5 x 2.5 mm <sup>2</sup>	125
16 85 125 SB	060444	8.0 – 13.0	round cable, e.g.: 3 x 1.5 mm <sup>2</sup> up to 5 x 2.5 mm <sup>2</sup>	125
16 90 130 SB	076940	8.0 – 13.0	round cable, e.g.: 3 x 1.5 mm <sup>2</sup> up to 5 x 2.5 mm <sup>2</sup>	130

## KNIPEX MultiStrip 10 Automatic Insulation Stripper

12  
42

Stripping without re-adjustment from 0.03 to 10.0 mm<sup>2</sup>  
 Universal blade geometry – robust and more durable  
 Ideal grip design with excellent haptics  
 Recessed wire cutter

- > Fully automatic adjustment to all single-, multi- and fine-stranded conductors with standard insulation throughout the entire capacity range from 0.03 to 10.0 mm<sup>2</sup>
- > No manual fine adjustment necessary
- > No damage to the conductors
- > The clamping jaws made of steel hold the cable in a way that prevents slipping without damaging the remaining insulation
- > With recessed wire cutter for Cu and Al conductors, stranded up to 10 mm<sup>2</sup> and single wire up to 6 mm<sup>2</sup>
- > Particularly smooth-running mechanics and very low weight
- > Replaceable blades block and length stop
- > Handle with soft-plastic zone for a steady grip
- > Body: plastic, fibreglass-reinforced
- > Blade: special tool steel, oil-hardened



PATENTED

Article No.	EAN		Stripping capacities		↔ mm
			mm <sup>2</sup>	AWG	
12 42 195	054580	MM	0.03 – 10	32 – 8	195

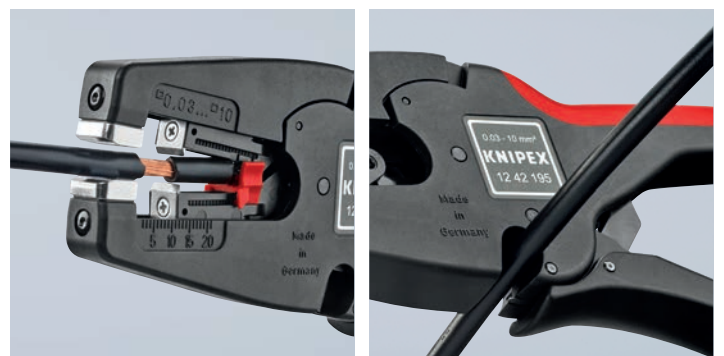
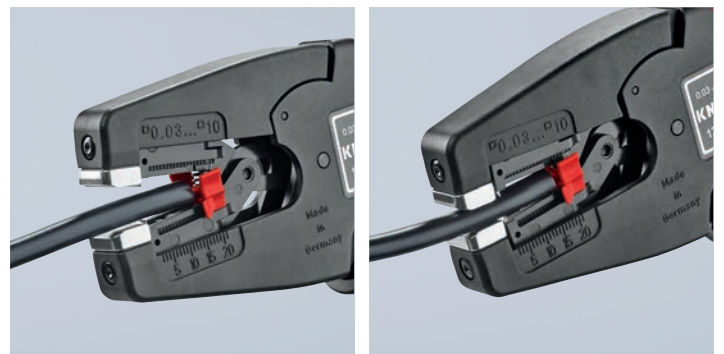

## Automatic Insulation Stripper

12  
64

- > Compact standard tool for all current cable cross-sections and insulating materials
- > For single, multiple and fine stranded cables of 0.2 up to 6 mm<sup>2</sup> with standard insulation
- > Adapts automatically to the respective cable cross-section; prevents damage to the conductor
- > Handy shape and low weight provide high operation comfort
- > Narrow head style for use in confined areas
- > With wire cutter for copper and aluminium wires up to 2.5 mm<sup>2</sup>
- > With adjustable length stop from 6.0 – 18.0 mm for cutting the same stripping lengths during repetitive work

Article No.	EAN		Stripping capacities		↔ mm
			mm <sup>2</sup>	AWG	
12 62 180	054573	MM	0.2 - 6	32 - 8	180



New

Upgraded



35

## Self-Adjusting Insulation Strippers

12

- > For single, multiple and fine stranded conductors with plastic or rubber insulation
- > Adapts automatically to the respective cable cross-section; prevents damage to the conductor
- > Cutting depth can be adjusted for different insulation materials
- > With wire cutter for copper and aluminium wires, multiple stranded up to 10 mm<sup>2</sup> and single stranded up to 6 mm<sup>2</sup>
- > Smoothly operating mechanism
- > Stripping blades and clamping jaws easily replaceable
- > Low weight
- > Body: plastic, fibreglass-reinforced
- > Blade: special tool steel, oil-hardened

### 200

- > For thin ribbon cables up to 10.0 mm width in a single pass
- > Adjustable length stop



12 40 200

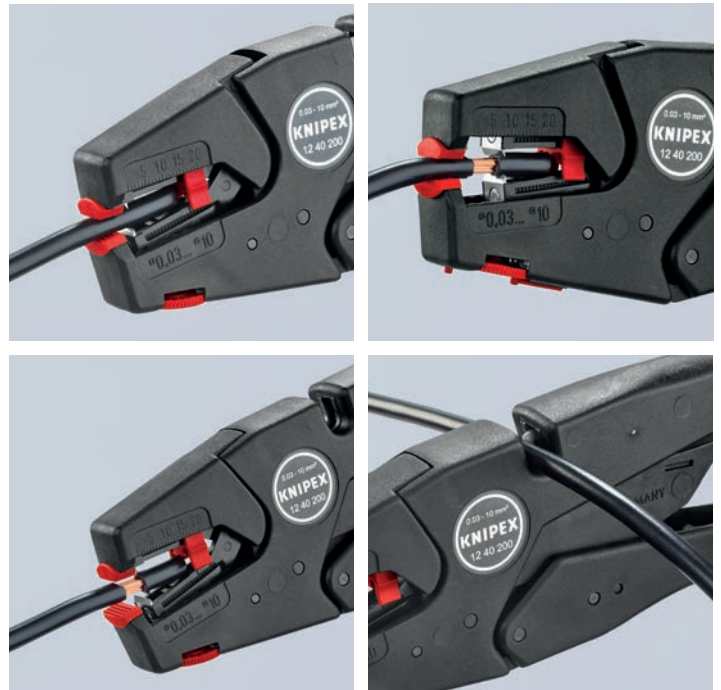

Article No.	EAN		Stripping capacities		↔ mm
			mm <sup>2</sup>	AWG	
12 40 200	026662	MM	0.03 – 10	32 – 8	200
12 50 200	034407	MM	2.5 – 16	14 – 6	200

## Automatic Insulation Stripper for flat cable

12  
64

- > For PVC insulated flat cables up to a max. 12 mm width and 0.75 to 2.5 mm<sup>2</sup>
- > Adapts automatically to the various conductor heights; prevents damage to the conductor
- > Long stripping lengths possible
- > Blade replaceable
- > Smoothly operating mechanism
- > Low weight
- > Body: plastic, fibreglass-reinforced
- > Blade: special tool steel, oil-hardened



Article No.	EAN		Stripping capacities		↔ mm
			mm <sup>2</sup>	AWG	
12 64 180	073284	MM	0.75 – 2.5	18 – 14	180

## Wire stripping tool for coax and data cable

16  
60

- > Universal stripping tool for coax cables RG 59, RG 6, RG 7, RG 11
- > For stripping outer sheath, shield and insulation in a single process
- > Adjustable stripping blade for data cable
- > Two stripping blades for cutting and stripping telephone ribbon cable (4P/6P/8P) in a single operation
- > Integrated blade for cutting data cables
- > Housing: plastic, impact-proof

Article No.	EAN 4003773-	Cable type	↔ mm
<b>16 60 06 SB</b>	077961	RG 59, RG 6, RG 7, RG 11	125



## Stripping Tool for coax cables

16  
60

- > For stripping all common coax cables between  $\varnothing$  4.8 – 7.5 mm (e.g. for TV- and satellite antenna), also suitable for PVC round cable 3 x 0.75 mm<sup>2</sup>
- > With length scale 5.0 – 20.0 mm
- > Double shell, folding back stripping tool
- > With opening spring and locking device
- > Body: plastic, fibreglass-reinforced

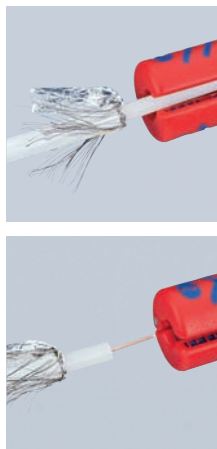

Article No.	EAN 4003773-	Stripping capacities		↔ mm
		$\varnothing$ mm	mm <sup>2</sup>	
<b>16 60 100 SB</b>	040811	4.8 – 7.5	3 x 0.75	100

## Stripping Tool for data cables

16  
65

- > For stripping UTP and STP data cables with diameters of 4.5 to 10.0 mm
- > Stripping device for cross-sections 0.2 / 0.3 / 0.8 / 1.5 / 2.5 / 4 mm<sup>2</sup>
- > Body: plastic, fibreglass-reinforced

Article No.	EAN 4003773-	Stripping capacities		↔ mm
		$\varnothing$ mm	mm <sup>2</sup>	
<b>16 65 125 SB</b>	043157	4.5 – 10.0	0,2 – 4,0	125

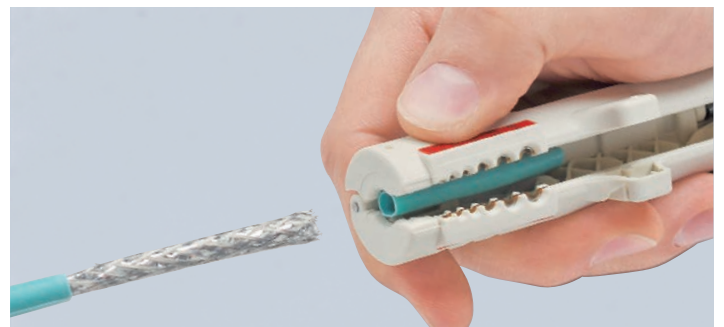

## Crimping Pliers

97

- > For cutting cables, stripping wire and crimping insulated and non-insulated terminals, connectors and plug type connectors
- > With threaded holes for cutting copper and brass screws threaded M 2.6/M 3/M 3.5/M 4 and M 5
- > Bolted joint for higher stability and even movement
- > Special steel, high-strength



97 21 215

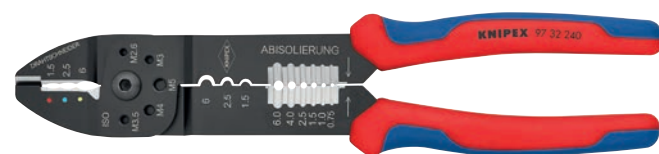

97 32 240

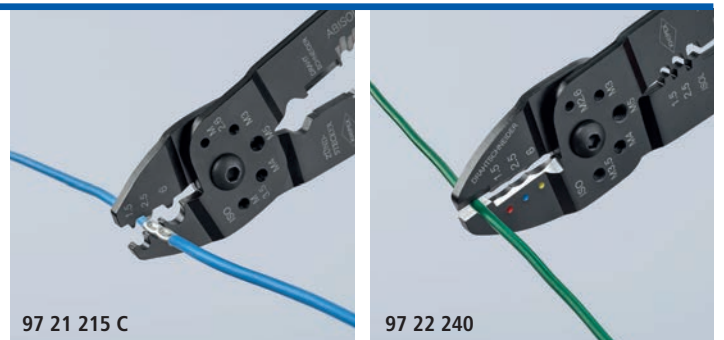

97 21 215 C

97 22 240

Article No.	EAN 4003773-	Capacity	Capacity		↔ mm
			mm <sup>2</sup>	AWG	
<b>97 21 215</b>	019688		0.5 – 6.0	20 – 10	230
<b>97 21 215 B</b>	019695		0.5 – 2.5	20 – 14	230
<b>97 21 215 C</b>	019701		0.5 – 6.0	20 – 10	230
<b>97 22 240</b>	070726		0.5 – 6.0	20 – 10	240
			0.5 – 2.5	20 – 14	
<b>97 32 240</b>	079491		0.5 – 6.0	20 – 10	240

- > Repetitive, high crimping quality due to precision dies and integral lock (self-releasing mechanism)
- > Crimping pressure has been set precisely (calibrated) in the factory, re-adjustable
- > Optimum transmission of force thanks to toggle lever for fatigue-reduced operation
- > Good handling thanks to favourable handle position, low weight, compact design and ergonomically shaped handles
- > Chrome vanadium electric steel in special quality, oil-hardened



97 52 36



97 52 38

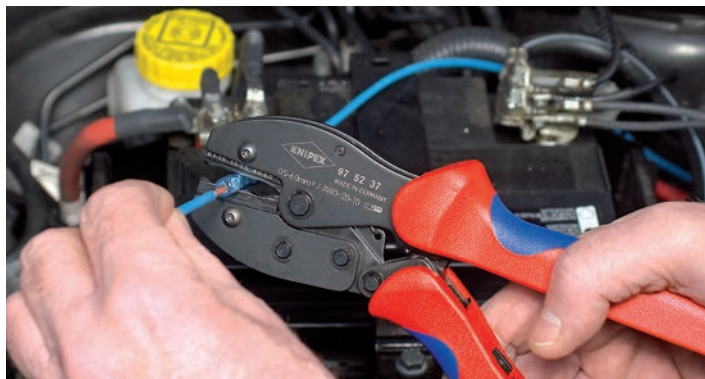

Article No.	EAN 4003773-	Capacity	Capacity		↔ mm
			mm <sup>2</sup>	AWG	
97 52 30	051855		1,5 - 10	16 - 12	220
97 52 33	051862		0,5 - 10	20 - 8	220
97 52 34	051879		0,1 - 2,5	27 - 14	220
97 52 35	051886		0,5 - 6	20 - 10	220
97 52 36	051893		0,5 - 6	20 - 10	220
97 52 37	063193		0,5 - 6	20 - 10	220
97 52 38	051909		0,25 - 6	24 - 10	220
97 52 50	051916				220

**Crimping Pliers for Western plugs**

- > Professional tool for cutting and stripping unshielded ribbon telephone cables
- > Exact crimping process due to parallel crimping
- > Repetitive, high crimping quality due to integral lock (self-releasing mechanism)
- > With length cutter and stripping knife for ribbon cables 6 and 12 mm length
- > With additional stripping device for round cables
- > Chrome vanadium electric steel in special quality, oil-hardened

**97 51 10**

- > For crimping 6- and 8-pole Western plugs type RJ 11/12 (9.65 mm width) and type RJ 45 (11.68 mm width)

**97 51 12**

- > For crimping 4-, 6- and 8-pole Western plugs type RJ 10 (7.65 mm width), type RJ 11/12 (9.65 mm width) and type RJ 45 (11.68 mm width)

Article No.	EAN 4003773-	Applications	↔ mm
97 51 10	043171	6- and 8-pole	190
97 51 12	043188	4-, 6- and 8-pole	200



97 51 12



**Now revised:**



# KNIPEX MultiCrimp® Crimping Pliers with changer magazine

97

Also for insulated and non-insulated wire ferrules 10 / 16 / 25 mm<sup>2</sup>  
Universal indent crimping die for non-insulated connectors

- > Crimping pliers with round magazine and five interchangeable dies
- > Just one tool for the most common crimping applications
- > Crimping dies changed quickly and easily without any additional tool
- > Sorted and protected storage of the interchangeable dies in a round magazine
- > Comfortable, powerful crimping pliers in professional quality
- > Same reliable crimping results as with fixed crimping dies
- > Repetitive, high crimping quality due to precision dies and integral lock

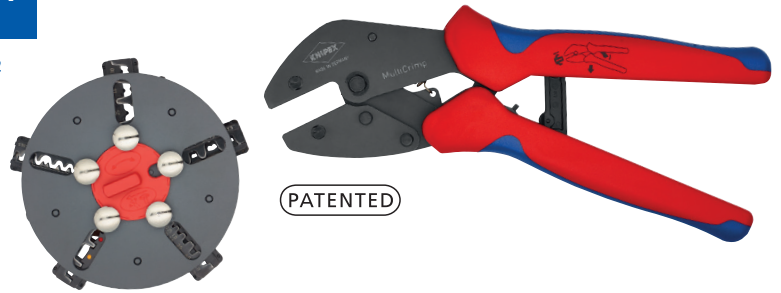

Compact, inexpensive and light-weight crimping pliers for fitting and repairs. The electrician now only needs one tool instead of five.



Changing the crimping dies: unlock the magazine position, take out the set of dies which the pliers have been pushed on



Fold in the service lever and press the pliers – ready for use again

Article No.	EAN 4003773-				Capacity mm <sup>2</sup>	AWG	↔ mm
97 33 02	066934		MM	KNIPEX MultiCrimp® non-insulated open plug type connectors (plug width 4.8 + 6.3 mm)	0.5 – 6	20 – 10	250
				insulated terminals, plug connectors and butt connectors	0.5 – 6	20 – 10	
				wire ferrules	0.5 – 6	24 – 10	
				wire ferrules	10 / 16 / 25	8 / 6 / 4	
				non-insulated crimp terminals, tube and compression cable lugs in accordance with DIN 46234 and DIN 46235 and non-insulated crimp, butt and press connectors in accordance with DIN 46341 and DIN 46267	0.5 – 10	20 – 8	

# Crimping Pliers short design

97

- > Repetitive, high crimping quality due to precision dies and integral lock (self-releasing mechanism)
- > Crimping pressure has been set precisely (calibrated) in the factory, re-adjustable
- > Optimum transmission of force thanks to toggle lever for fatigue-reduced operation
- > Good handling due to 20° angled head, low weight and short design
- > Chrome vanadium electric steel in special quality, oil-hardened

97 59 14

> Available as accessory: locator for non-insulated open plug-type connectors

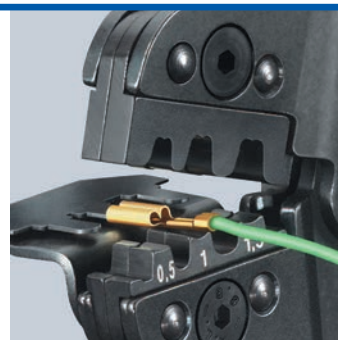

97 52 20

Article No.	EAN 4003773-			Applications	Capacity mm <sup>2</sup>	AWG	↔ mm
97 52 14	026808		MM	non-insulated open plug type connectors (plug width 2.8 + 4.8 mm)	0.1 – 1.5	26 – 16	195
97 52 20	026853		MM	COAX-, BNC- and TNC-connectors			195
97 59 14	026976	Locator for 97 52 14 short design					

# Self-Adjusting Crimping Pliers for wire ferrules

with lateral access

97  
55

## Square compression now additionally also for wire ferrules up to 16 mm<sup>2</sup>

- > Suitable in particular for all twin wire end sleeves up to 2 x 4 mm<sup>2</sup> or 2 x AWG 12
- > Square compression for ideal contact surfaces in the clamp connection

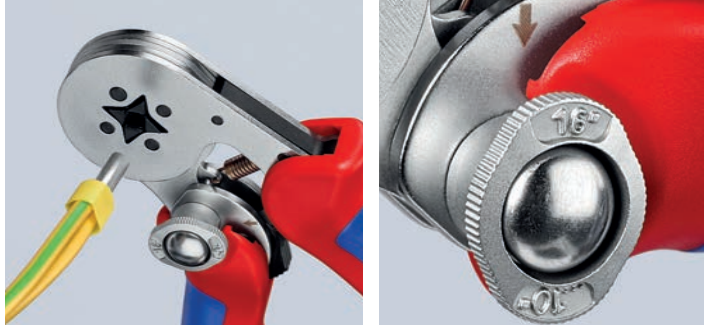

Crimping capacity can be switched over simply from 10 mm<sup>2</sup> to 16 mm<sup>2</sup>

**The small crimping pliers for wire ferrules with two major advantages for the user:**  
Automatic adjustment to the end sleeves used: This makes work easier for the professional and offers reliable and fast crimping.



97 55 04

0.08 - 10 mm<sup>2</sup> + 16 mm<sup>2</sup>

PATENTED

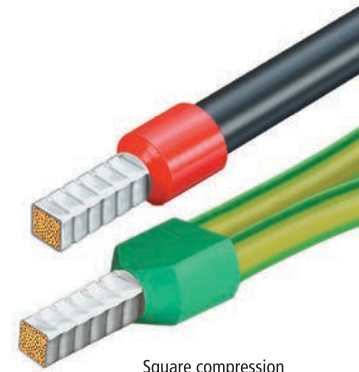

Square compression

## Proven functions

- > For crimping wire ferrules according to DIN 46228 parts 1 + 4
- > Self-adjusting adaptation to the desired end sleeve (ferrule) size: no wrong crimps caused by using the wrong die
- > Repetitive, high crimping quality due to integral lock (self-releasing mechanism)
- > Tools have been set precisely (calibrated) in the factory
- > Optimum transmission of force thanks to toggle lever for fatigue-reduced operation
- > Handy shape and low weight provide high operation comfort

## Expanded capacity of hexagonal crimping up to 10 mm<sup>2</sup>

- > Suitable in particular for all twin wire ferrules up to 2 x 4 mm<sup>2</sup> or 2 x AWG 12
- > Hexagonal compression for confined connection dimensions



97 55 14

0.08 - 10 mm<sup>2</sup>

PATENTED

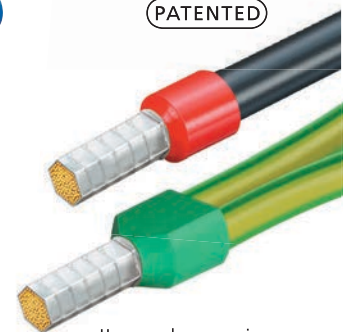

Hexagonal compression

Article No.	EAN			Pliers	Handles	Application	Capacity mm <sup>2</sup>	AWG	↔ mm
97 55 04	084853			chrome	with multi-component grips	wire ferrules	0,08 - 10 + 16	28 - 6	180
97 55 14	084860			chrome	with multi-component grips	wire ferrules	0,08 - 10	28 - 8	180



# Self-Adjusting Crimping Pliers for wire ferrules

with front loading

97  
53

- > For crimping wire ferrules according to DIN 46228 parts 1 + 4
- > Self-adjusting adaptation to the desired end sleeve (ferrule) size: no wrong crimps caused by using the wrong die
- > Front loading of the wire ferrules into the tool
- > Repetitive, high crimping quality due to integral lock (self-releasing mechanism)
- > Crimping pressure has been set precisely (calibrated) in the factory, re-adjustable
- > Optimum transmission of force thanks to toggle lever for fatigue-reduced operation
- > Handy shape and low weight provide high operation comfort
- > Chrome vanadium electric steel in special quality, oil-hardened

## 97 53 08

- > Compression from 0.08 – 10.0 mm<sup>2</sup> in one profile
- > Wire ferrules up to 2.5 mm<sup>2</sup> can also be loaded parallelly from the side
- > Suitable in particular for all twin wire ferrules up to 2 x 4 mm<sup>2</sup> or 2 x AWG 10

## 97 53 09

- > Compression from 0.08 – 10.0 and 16.0 mm<sup>2</sup> in one profile
- > With selector lever for setting the crimping area either to 0.08 – 10 mm<sup>2</sup> or 16 mm<sup>2</sup>
- > Suitable in particular for all twin wire ferrules up to 2 x 6 mm<sup>2</sup> or 2 x AWG 8



97 53 08  
MM



97 53 09  
MM



Square compression

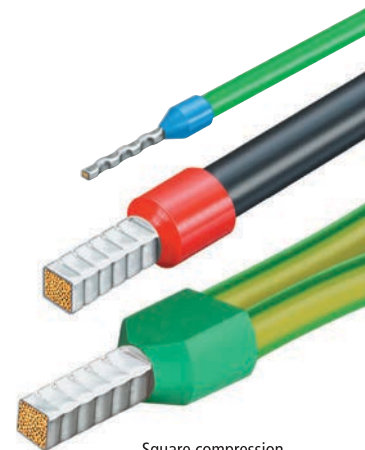

Square compression

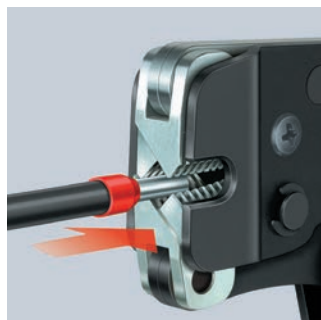

Front loading of wire ferrules e.g. in switchboards

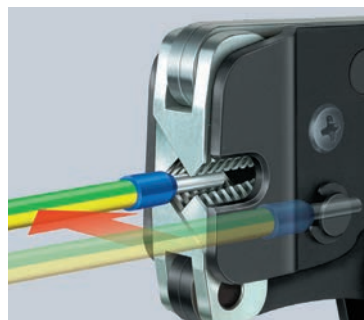

97 53 08: lateral loading of end sleeves (ferrules) up to 2.5 mm<sup>2</sup> parallelly from the side e.g. in confined areas

### The crimping pliers for wire ferrules with three great advantages for the user:

- > Automatic self-adjustment to the end sleeve (ferrule) used: this allows the specialist to work with less strain and enables secure, reliable and quick crimping
- > Range of applications also for large cross-sections: square crimping 0.08 to 10.0 + 16.0 mm<sup>2</sup>
- > Front loading: very helpful under difficult working conditions in confined areas.

Article No.	EAN 4003773-			Pliers	Handles	Applications	Capacity mm <sup>2</sup>	AWG	↔ mm
97 53 08	040187			burnished	with multi-component grips	wire ferrules	0.08 - 10	28 - 8	190
97 53 09	044550			burnished	with multi-component grips	wire ferrules	0.08 - 10 + 16	28 - 6	190

## Crimping Pliers for wire ferrules

97

- > For crimping wire ferrules according to DIN 46228 parts 1 + 4 in the range from 0.25 up to 2.5 mm<sup>2</sup>
- > Crimping in marked trapezoidal dies for reliable connections between the sleeve and the conductor
- > Vanadium electric steel; forged, oil-hardened



97 61 145 A



97 68 145 A

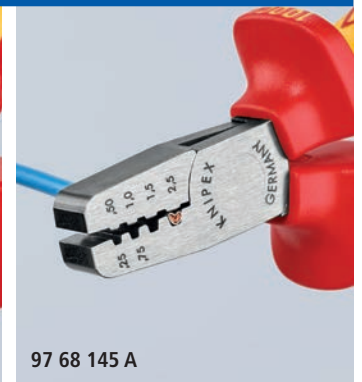

97 68 145 A



97 68 145 A

Article No.	EAN 4003773-		Capacity mm <sup>2</sup>	AWG	Number of crimping positions	↔ mm
97 61 145 A	035558		0.25 - 2.5	24 - 14	4	145
97 62 145 A	060154		0.25 - 2.5	24 - 14	4	145
97 68 145 A	071754	⚡ 1000 V	0.25 - 2.5	24 - 14	4	145

## Crimping Pliers for wire ferrules

97  
7

- Easy crimping due to optimised transmission ratio
- Light and slim design

- > For crimping wire ferrules according to DIN 46228 parts 1 + 4 from 0.25 to 16 mm<sup>2</sup>
- > Crimping in marked half-round dies for reliable connections between the sleeve and the conductor
- > 9 particularly deep dies with conical side faces



97 78 180

Article No.	EAN 4003773-		Capacity		Number of crimping positions	↔ mm
			mm <sup>2</sup>	AWG		
97 71 180	040668		0.25 - 16	24 - 6	9	180
97 72 180	060185		0.25 - 16	24 - 6	9	180
97 78 180	072003	⚡ 1000 V	0.25 - 16	24 - 6	9	180
97 78 180 T	081531	⚡ 1000 V	0.25 - 16	24 - 6	9	180

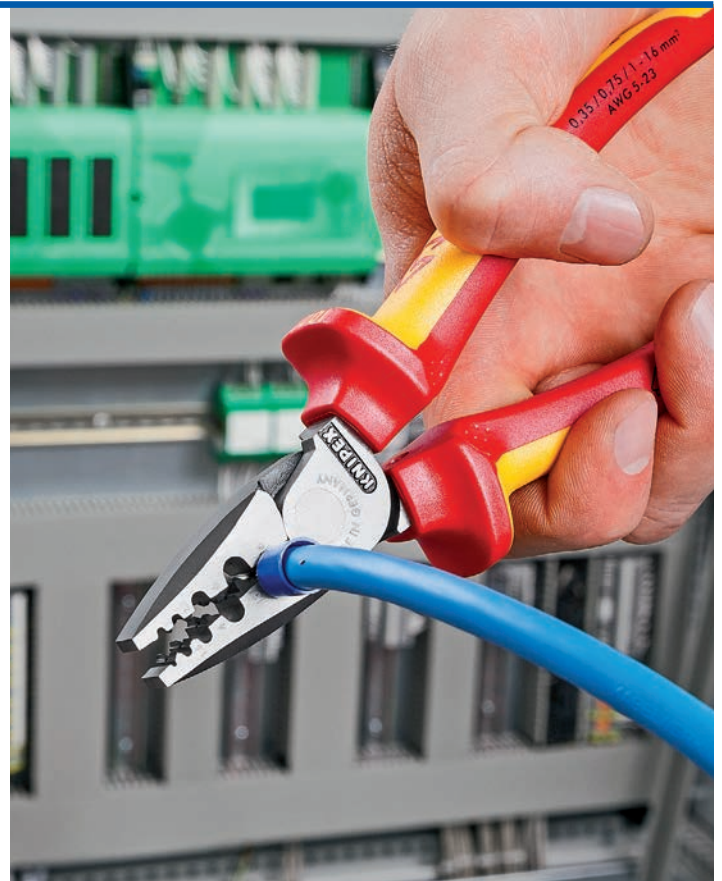

## Crimp System Pliers for exchangeable crimping dies

97  
43

- > Just one tool for almost 1000 crimping applications
- > Almost parallel crimping die movement
- > Repetitive, high crimping quality due to precision dies and integral lock (self-releasing mechanism)
- > Crimping pressure has been set precisely (calibrated) in the factory, re-adjustable
- > Optimum transmission of force due to lever action for fatigue-reduced operation
- > Ergonomically designed handles
- > Different locators for precise positioning of the connectors
- > Crimping dies for applications not covered in the range offered here, may be available on request
- > Chrome vanadium electric steel in special quality, oil-hardened

### 97 43 200

- > Comes in a plastic case; foam insert with recesses for crimping dies and locators; with service tool (Allen key), screws and nuts
- > Without crimping dies

### 97 43 200 A





- > Pliers without crimping dies, without case

### 97 43 05

- > With attached crimping dies for non-insulated open plug-type connectors (4.8 and 6.3 mm connector width)

### 97 43 06

- > With attached crimping dies for insulated terminals and plug connectors

Article No.	EAN	Applications	Capacity		↔ mm
			mm <sup>2</sup>	AWG	
97 43 200 A	4003773-071587	Crimp System Pliers for exchangeable crimping dies*			200
97 43 200	030812	Crimp System Pliers, comes in a plastic case			200
97 43 05	031031	  	0.5 – 6	20 – 10	200
97 43 06	031048	 	0.5 – 6	20 – 10	200

\* Special profiles on request [www.knipex.com](http://www.knipex.com)



97 43 200 A



## KNIPEX eCrimp

97

The KNIPEX eCrimp is the first electromechanically actuated model of crimping pliers for comfortable and reliable crimping of non-insulated terminals up to 25 mm<sup>2</sup> and wire ferrules up to 50 mm<sup>2</sup>.

- > Strong electromechanical drive, no hydraulic components, no leakages
- > Possible use of over 40 KNIPEX crimping dies and locators as well as more than 1000 special crimping dies from the proven Crimp System Pliers (97 43 200)
- > Ergonomically optimised, user-friendly working height during workshop operation
- > Low noise level
- > Powerful Li-ion rechargeable battery (12 V; 1.5 Ah; 18 Wh); charge time approx. 30 min; no memory effect
- > Approx. 170 operating cycles for plug-in connectors with 10 mm<sup>2</sup> nominal size with a single battery charge
- > Tether attachment point to prevent falling during field work

Article No.	EAN	Mains voltage/frequency	Connector socket
97 43 E	076858	230 V / 50 Hz	CEE 7/16



PATENTED

### Long servicing intervals (up to 25.000 crimping actions)!

The KNIPEX eCrimp is designed to only require servicing after 25.000 crimping actions. This means the intervals between servicing the electromechanical crimping pliers is 2.5 : 1 in relation to conventionally actuated crimping pliers.

The pliers are therefore available for crimping use for considerably longer. They do not need to be sent away frequently for servicing. High availability without downtimes while being serviced.

Article No.	EAN 4003773-			Applications	Capacity mm <sup>2</sup>	AWG	Capacity SW mm	Sleeves Ø mm	Number of crimping positions
97 49 04	030850			non-insulated open plug type connectors (plug width 2.8 + 4.8 mm)	0.1 – 2.5	27 – 14			4
97 49 05	030867			non-insulated open plug type connectors (plug width 4.8 + 6.3 mm)	0.5 – 6	20 – 10			3
97 49 06	030836			insulated terminals, plug connectors + butt connectors	0.5 – 6	20 – 10			3
97 49 08	030874			insulated and non-insulated wire ferrules	0.25 – 6	24 – 10			5
97 49 09	030881			insulated and non-insulated wire ferrules	10 / 16 / 25	8 / 6 / 4			3
97 49 10	076896			non-insulated tubular cable lugs and crimp terminals in accordance with DIN 46237 and non-insulated butt and crimp connectors in accordance with DIN 46341	0.25-0.75 / 1-1.5 / 2.5	14 / 16-18 / 18-20			3
97 49 11	076902			non-insulated crimp terminals, tube and compression cable lugs in accordance with DIN 46234 and DIN 46235 and non-insulated crimp, butt and press connectors in accordance with DIN 46341 and DIN 46267	4 / 6 / 10	8 / 10 / 12			3
97 49 14	077756			for non-insulated crimp terminals, tube and compression cable lugs in accordance with DIN 46234 and DIN 46235 and non-insulated crimp, butt and press connectors in accordance with DIN 46341 and DIN 46267	0.5 – 10	20 – 8			4
97 49 15	043164			lug connectors and non-insulated open plug type connectors (plug width 6.3 mm)	1.25 – 2.5 + 3 – 6	18 – 14 / 18 – 10			2 + 1
97 49 16	040675			insulated terminals + cable connectors	10 – 16	8 / 6			2
97 49 18	063186			Twin wire ferrules for two flexible conductors	2 x 6 / 2 x 10 / 2 x 16	2 x 10 / 2 x 8 / 2 x 6			3
97 49 19	030898			insulated and non-insulated wire ferrules	35 – 50	2 / 0			2
97 49 20	045069			F-connectors for TV and satellite connections			7.0 / 8.4 / 8.1	7.7 / 9.5 / 9.5	3
97 49 23	052135			non-insulated terminals + cable connectors	16 + 25	6 + 4			2
97 49 24	030911			D Sub; HD 20; HDE plug	0.03 – 0.56	32 – 20			3
97 49 30	030904			non-insulated crimp connectors in accordance with DIN 46267	1.5 – 4	16 – 12			3
97 49 35	034315			spark plug connectors and distributors	1	18			5
97 49 40	030959			coax connectors RG 58. 59. 62. 71. 223			5.4 / 6.48 / 1.72	6.4 / 7.6 / 2.1	3
97 49 44	041443			rolled contacts	0.14 – 1.5	26 – 16			3
97 49 50	030966			coax connectors/ car phone RG 58. 74. 188. 316			3.25 / 4.52 / 5.41 / 1.72 / 1.07 / 0.72	3.9 / 5.4 / 6.4 / 2.1 / 1.3 / 0.95	6
97 49 54	041450			modular plugs	0.5 – 2.5	20 – 14			4
97 49 59	073734			solar cable connectors Helios H4 (Amphenol)	2.5 + 4 + 6 + 10	14 – 10			3
97 49 60	030928			turned contacts (HTS + Harting)	0.14 – 4	26 – 12			4
97 49 61	045137			turned contacts	1.5 / 2.5 / 4 / 6	10 / 12 / 14 / 16			4
97 49 62	063179			solar cable connectors (Huber + Suhner)	2.5 + 4	14 + 12			3
97 49 63	066675			solar cable connectors (Huber + Suhner)	4 + 6	12 / 10			3
97 49 64	044055			ABS connectors in motor vehicles	1 – 6	18 – 10			2
97 49 65	066682			solar cable connectors MC3 (Multi-Contact)	2.5 – 6	14 – 10			3
97 49 66	066699			solar cable connectors MC4 (Multi-Contact)	2.5 – 6	14 – 10			3
97 49 66 4	072096			solar cable connectors MC4 (Multi-Contact) cutting - stripping - crimping	4	12			1
97 49 66 6	072102			solar cable connectors MC4 (Multi-Contact) cutting - stripping - crimping	6	10			1
97 49 67	066705			solar cable connectors (Hirschmann)	2.5 – 6	14 – 10			3
97 49 68	066712			solar cable connectors (Tyco)	1.5 – 6	16 – 10			4
97 49 69 1	072119			solar cable connectors gesis® solar PST 40 (Wieland)	0.14 – 4 mm <sup>2</sup>	16 / 14 / 12			2
97 49 69 2	072126			solar cable connectors gesis® solar PST 40 (Wieland)	4 – 10	12 – 8			3
97 49 70	030942			Western plugs	4 / 6 / 8-poles	RJ 10 / 11 / 12 / 45			3
97 49 72	076957			solar cable connectors MC3 (Multi-Contact)	4 / 6 / 10	8 / 10 / 12			3

Special profiles on request [www.knipex.com](http://www.knipex.com)

compression joints in conformance to DIN 46267

## Range boxes of wire ferrules

Brand sleeves from German production

97

### Practical dispenser box, stackable and reclosable

- > Handy and transparent dispenser box
- > Rotatable lid with opening to take out individual wire ferrules
- > Format: Ø 90 mm, height 44 mm

#### 97 99 905 / 97 99 906 / 97 99 907

- > equipped with insulated wire ferrules to DIN colour code

#### 97 99 908 / 97 99 909

- > equipped with insulated twin wire ferrules to DIN colour code

#### 97 99 910 / 97 99 911

- > equipped with uninsulated wire ferrules



Article No.	EAN	
	4003773-	
97 99 905	082446	With 30 pieces each insulated 0.25 / 0.34 / 0.5 / 1 mm <sup>2</sup> wire ferrules
97 99 906	082453	With 50 pieces each insulated 0.5 and 2.5 mm <sup>2</sup> and 100 pieces each 0.75 / 1 / 1.5 mm <sup>2</sup> wire ferrules
97 99 907	082460	With 50 pieces insulated 4.0 mm <sup>2</sup> , 20 pieces each 6.0 and 10.0 mm <sup>2</sup> , 10 pieces 16 mm <sup>2</sup> wire ferrules
97 99 908	082477	With 50 pieces each twin wire ferrules 2 x 0.75 / 1 / 1.5 / 2.5 mm <sup>2</sup>
97 99 909	082484	With 20 pieces twin wire ferrules 2 x 4 mm <sup>2</sup> , 10 pieces each 2 x 6 and 2 x 10 mm <sup>2</sup> , 5 pieces 2 x 16 mm <sup>2</sup>
97 99 910	082491	With 500 pieces each 0.5 and 0.75 mm <sup>2</sup> , 400 pieces 1.0 mm <sup>2</sup> , 300 pieces 1.5 mm <sup>2</sup> , 200 pieces 2.5 mm <sup>2</sup> non-insulated wire ferrules
97 99 911	082507	With 150 pieces 4.0 mm <sup>2</sup> , 75 pieces each 6.0 and 10.0 mm <sup>2</sup> , 50 pieces 16.0 mm <sup>2</sup> non-insulated wire ferrules

## F-compression connector

97  
9

- > Suitable for coax cable with outer diameter of 7 mm and dielectric from 4.7 mm diameter (all standard coax cable with Ø 1.1 mm inner conductor)
- > Nitin-6™ coating ensures excellent protection against environmental influences
- > Waterproof (8h/at a depth of 30 m), ideal for connection to LNB and external antennae
- > Suitable for KNIPEX 97 40 20 compression tool
- > 10 Cablecon F-compression connectors in a blister pack

Artikel-Nr.	EAN	
	4003773-	
97 99 500	082378	10 pieces each



## KNIPEX CoBolt® S

71

### Compact and powerful

Extremely high cutting performance in a convenient length of 160 mm

### Small, slim head for excellent accessibility

- > Compact and powerful: cuts bolts, nails, rivets etc. up to Ø 4.4 mm
- > Heavy duty, induction-hardened cutting edge for thin, hard wire, screws and springs. Cutting edge hardness approx. 64 HRC
- > Less physical effort due to efficient lever action mechanism

Article No.	EAN					
	4003773-	Ø mm	Ø mm	Ø mm	Ø mm	mm
71 01 160	082668	5.3	4.4	3.2	3.0	160



## Four-Mandrel Crimping Pliers for turned contacts

97  
7

- > For crimping turned contacts
- > Four-mandrel crimping for top-quality crimping connections
- > Mandrel gauge to check the basic setting
- > Fine adjustment of pressure depending on the conductor's diameter by means of adjusting wheel
- > Repetitive, high crimping quality due to integral lock (self-releasing mechanism)
- > Optimum transmission of force due to highly effective lever action for fatigue-reduced operation
- > High operation comfort thanks to handy shape
- > Chrome vanadium electric steel in special quality, oil-hardened



PATENTED

Article No.	EAN	Applications	Capacity mm <sup>2</sup>	↔ mm
97 52 65	045236	turned contacts (Harting; Ilme; Phoenix; Amphenol; Walther; HTS; Contact; Weidmüller)	0.14 – 6	230
97 59 65 2	071600	Universal Locator for 97 52 65 / 97 52 65 A / 97 52 65 DG / 97 52 65 DG A		

## Compression Tool for coax connectors

97  
40

For crimping F, BNC and RCA connectors

Robust design

- > Suitable for RG 59/6/11 cable
- > Rotatable head for different cable sizes
- > Rotatable insert for various types of connector
- > Adjusting screw for various connector lengths
- > Applicable among others for compression connectors Kathrein EMK 12; Cablecon F-56 CX3 5.1; Astro FKS 06



Article No.	EAN	Applications	↔ mm
97 40 20 SB	077626	for F, BNC and RCA connectors	175

## Insertion tool

for LSA-Plus and identical construction design

97

- > Tool for putting on boards, sockets and fields
- > Pushing down and cutting in one operation
- > For UTP and STP cables, conductor 0.4 – 0.8 mm dia.
- > With integrated pulling hook and release blade
- > Housing: plastic, impact-proof

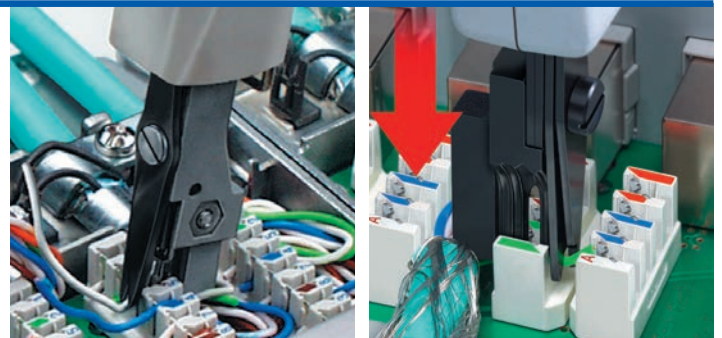

Article No.	EAN	Applications	Capacity Ø mm	↔ mm
97 40 10	044895	UTP- and STP-cables, LSA-Plus and identical	0.4 – 0.8	175



## Pipe Cutter

for plastic conduit pipes and hoses

90  
2

- > For cutting thin walled plastic pipes (conduit plastic pipes) and flexible hoses, also with fabric reinforcement, of plastic and rubber up to Ø 25 mm/1"
- > Not suitable for cutting cables
- > With opening spring and locking device
- > Tool body: plastic, fibreglass-reinforced
- > Blades: special tool steel, oil-hardened, interchangeable

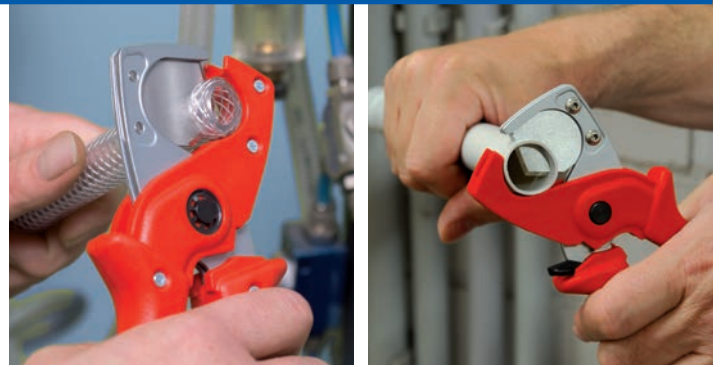

Article No.	EAN		Cutting capacity Ø mm	↔ mm
90 20 185	4003773-067122	MM	25	185

## Pipe Cutter

for plastic conduit pipes

94  
10

- > For clean cutting of plastic pipes (e.g. plastic conduit pipes) with Ø 6 – 35 mm
- > Not suitable for cutting cables
- > Blade is replaceable and can be retracted from any position
- > Low force requirement due to special blade geometry and optimum transmission
- > Minimum operator fatigue due to ergonomic handle design and incremental ratchet blade feed
- > Housing: die-cast aluminium, red lacquered
- > Blade: special tool steel, oil-hardened



Article No.	EAN		Cutting capacity Ø mm	Cutting edge length mm	↔ mm
94 10 185	4003773-047025	MM	6 – 35	35	185

## Vinyl Shears

also for cable ducts

95  
02

- > For cutting and shortening cable ducts, also for plastic material up to 4.0 mm thickness
- > Special lever transmission
- > Very effective blade geometry
- > Tool body: high-grade chrome vanadium electric steel, oil-hardened

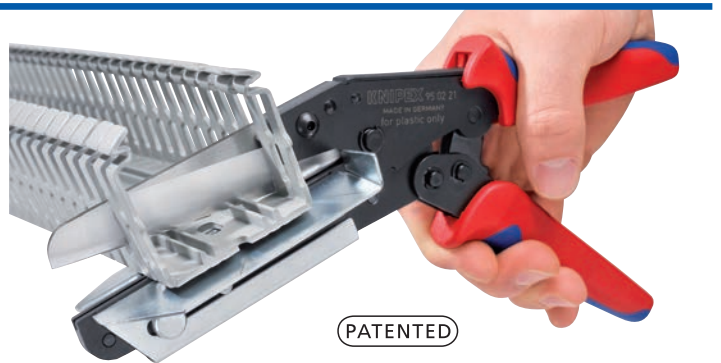

Article No.	EAN		Cutting capacities mm	Cutting capacity mm	↔ mm
95 02 21	4003773-052128	MM	110	max. 4	275

## Notching Pliers

90

- > Special pliers for notching recesses into plastic ledges and plastic casings for electric and sanitary installation
- > Notches can be enlarged by initial and final cut
- > Clean cut edges – no trimming activities needed
- > With opening spring, opening limiter and locking lever



Article No.	EAN		Capacity mm	↔ mm
90 61 20	4003773-051954	MM	20 x 29	250

## Wire Rope Cutter

also for high-strength wire rope

95

Compact size, low weight, high performance level

High transmission joint design makes cutting 20% easier

Especially precise cutter guide thanks to box joint fitted with additional stabilisation plate

- > For cutting high-strength wire ropes up to Ø 4 mm and cable up to Ø 6 mm
- > At just 160 mm long, considerably more powerful than many larger wire rope cutters
- > Convenient work thanks to opening spring
- > Secured by locking device during transport
- > Cutting edges additionally induction hardened
- > Ball bearing steel for a long service life

Article No.	EAN 4003773-	Ø mm	Ø mm	↔ mm
95 62 160	082354	6.0	4.0	160
95 62 160 SB	082712	6.0	4.0	160



Doppelt gelagertes Gelenk



User-friendly and reliable thanks to locking device and opening spring

PAT. PEND.

## KNIPEX Twistor16®

Self-adjusting crimping pliers for wire ferrules with rotating crimp head

97  
53

Crimp head can be freely rotated 360°, with 8 locking positions

Square crimp profile, high capacity range of 0.14 to 16 mm²

Wire ferrules can be crimped from almost any working position

- > Crimping pliers adjust automatically to different cross-sections
- > Crimp opening accessible from both sides, extra-long end sleeves can be fed in
- > Crimping of twin wire ferrules up to 2 x 6 mm² possible
- > Repetitive, high crimping quality due to integral lock (self-releasing mechanism)
- > Light and handy tool, manual force reinforced by toggle lever mechanism
- > Chrome vanadium electric steel in special quality, oil-hardened



PAT. PEND.

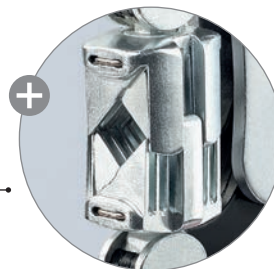

Crimp head can be rotated 360°

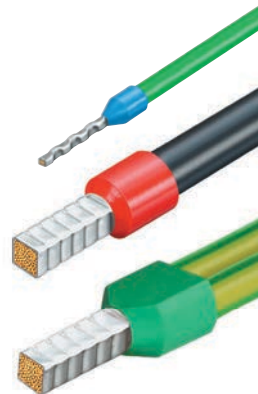

Hexagonal compression

Uniquely flexible: connectors can be inserted in the rotatable crimp head from almost any position

Article No.	EAN 4003773-			Capacity mm²	AWG	Number of crimping positions	↔ mm
97 53 18	082729			0.14 - 16	26 - 6	1	200



## Wire Rope Cutters (forged)

95

- > With two crimping dies for end caps on Bowden cable sheaths and end ferrules for traction cables
- > Comfortable work thanks to handy, slim design and internal opening spring
- > Bolted joint for precise blade guidance, re-adjustable
- > High leverage for reduced effort
- > Cutting-edge hardness approx. 64 HRC
- > Chrome vanadium heavy-duty steel, forged, multi stage oil-hardened



Article No.	EAN 4003773-	Ø mm	Ø mm	Ø mm	Ø mm	↔ mm
95 61 190	040651	7.0	5.0	4.0	2.5	190

## KNIPEX CoBolt® Compact Bolt Cutters

71

Micro-structured cutting edge allows easy cutting of large cross-sections

With gripping surface below the joint for gripping and pulling wires with a diameter as from 1.0 mm

- > Precision cutting edges for soft and hard wire as well as piano wire
- > Cuts bolts, nails, rivets, etc. up to Ø 5.2 mm
- > Most efficient joint design ensures exceptional cutting performance
- > Cutting edges additionally induction hardened, cutting edge hardness approx. 64 HRC
- > Opening spring and locking device are integrated in the handles also for comfortable work and protected transport
- > Chrome vanadium heavy-duty steel, forged, multi stage oil-hardened



71 01 / 02 / 12 200  
Micro-structured cutting edge

71 01 / 02 / 12 and 71 32 200  
Gripping surface below the joint



71 01 200

Article No.	EAN 4003773-		Ø mm	Ø mm	Ø mm	Ø mm	↔ mm
71 01 200	033165		6.0	5.2	4.0	3.6	200
71 02 200	047056		6.0	5.2	4.0	3.6	200
71 12 200	066859	W	6.0	5.2	4.0	3.6	200
71 32 200	066880	W	6.0	5.2	4.0	3.6	200

## Pen-Style Control Cabinet Key for all standard cabinets and shut-off systems

00

- > Easy to carry pen-style control cabinet key with fastening clip
- > Four different key profiles can be utilised by swivelling the key holder
- > For control cabinets and shut-off systems in the supply of gas, water and electricity
- > For technical installations in buildings, e.g. air conditioning and ventilation systems, shut-off valves, mains switchboards, etc.
- > Universal 1/4" bit adapter for standard bits (permanent magnet for retaining)
- > Additional bit adapter for 1/4" bits inside one key profile
- > With 2 reversible bits: cross recess PH / slot 7.0 x 1.2 mm and TX20 / TX25



00 11 07

Article No.	EAN 4003773-	mm	mm	Ø mm	↔ mm
00 11 07	063018	5 / 6 / 8	9	3 - 5	145

## Control Cabinet Keys

00

- > For control cabinets and shut-off systems in the supply of gas, water and electricity
- > For technical installations in buildings, e.g. air conditioning and ventilation systems, shut-off valves, mains switchboards, etc.
- > With bit insert: slot 1.0 x 7 mm and cross recess PH2 (00 11 03 + 00 11 04)

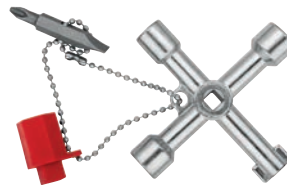

00 11 03

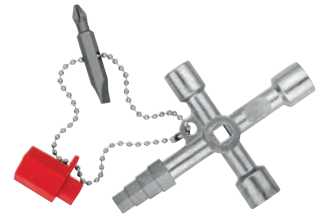

00 11 04



00 11 06

Article No.	EAN 4003773-	mm	mm	Ø mm	mm	mm	mm
00 11 03	041658	5 / 6 / 8	9	3 – 5	–	–	76
00 11 04	048954	5 / 7 / 8	9 – 10	–	–	6 / 7 / 8 / 9	90
00 11 06	071334	5 / 6 / 7 – 8 / 9 – 10	7 / 8 – 9 / 10 – 11	3 – 5	6	–	90

## KNIPEX TwinKey®

for all standard cabinets and shut-off systems

00

1

10 profiles. 2 crosses. 1 key.

All common locking systems

- > Multifunctional key for the actuation of locking systems from the areas of facilities engineering (heating and sanitation, air conditioning, electro technology), gas and water supply and shut-off-systems
- > 8-arm version: two 4-way spider keys connected in a space-saving way using magnets
- > Reversible bit: 1.0 x 7 mm slot and PH2 cross slot
- > Key and reversible bit joined by stable stainless steel wire
- > Weight-optimised zinc die-cast design

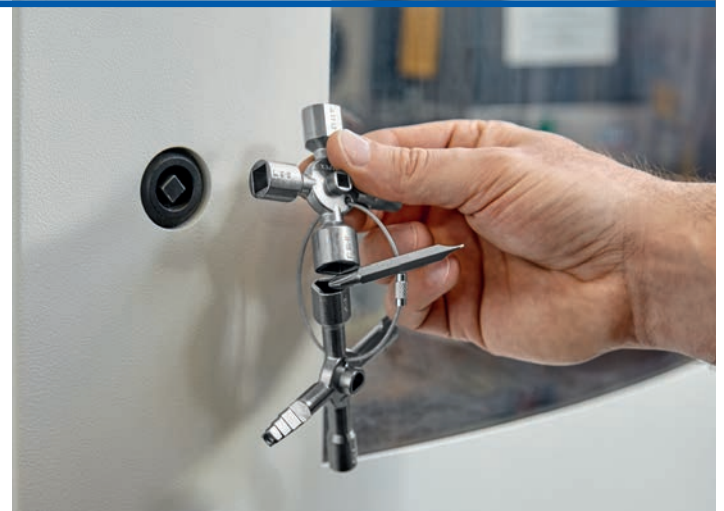

PATENTED

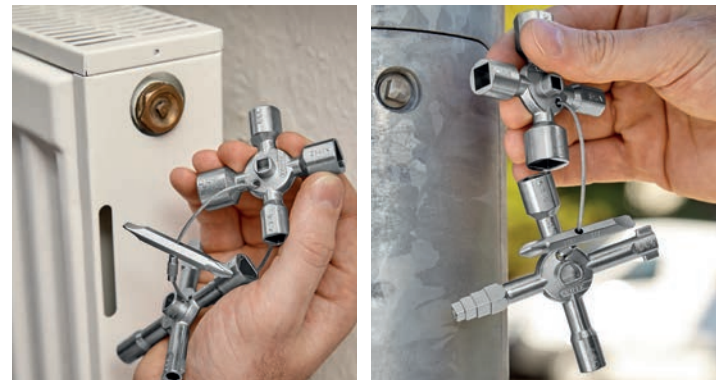

Article No.	EAN 4003773-	mm	mm	Ø mm	mm	mm	mm
00 11 01	074670	5 / 6 – 7 / 8 – 9 / 10 – 11	7 – 8 / 9 – 10 / 11 – 12	3 – 5	6	6 – 9	92

> Tools in a plastic deep-drawn tray with transparent lid



00 20 12 V01



00 20 12 V02



00 20 12 V03



00 20 12 V04



00 20 12 V05



Article No.	EAN			Quantity	Nominal size
00 20 12 V01	4003773-075523		Screwdriver Set		
		<ul style="list-style-type: none"> <li>98 20 30</li> <li>98 20 40</li> <li>98 20 55</li> <li>98 20 65</li> </ul>	Screwdrivers for slotted screws	1	3.0 mm
		<ul style="list-style-type: none"> <li>98 24 01</li> <li>98 24 02</li> </ul>	Screwdriver for cross recessed screws, Phillips®	1	4.0 mm
				1	5.5 mm x 125 mm
				1	6.5 mm
00 20 12 V02	082538		VDE Screwdriver Set Slotted / Phillips®		
		<ul style="list-style-type: none"> <li>98 20 30</li> <li>98 20 40 SL</li> <li>98 20 55 SL</li> <li>98 20 65 SL</li> </ul>	Screwdrivers for slotted screws	1	3.0 mm
			Screwdriver (Slim) for slotted screws	1	4.0 mm
				1	5.5 mm x 125 mm
				1	6.5 mm
		<ul style="list-style-type: none"> <li>98 24 01 SL</li> <li>98 24 02 SL</li> </ul>	Screwdriver (Slim) for cross-recessed screws, Phillips®	1	PH 1
				1	PH 2
00 20 12 V03	082545		VDE Screwdriver Set Phillips® / Pozidriv®		
		<ul style="list-style-type: none"> <li>98 24 00</li> <li>98 24 01 SL</li> <li>98 24 02 SL</li> </ul>	Screwdriver for cross recessed screws, Phillips®	1	3.0 mm
			Screwdriver (Slim) for cross-recessed screws, Phillips®	1	4.0 mm
				1	5.5 mm x 125 mm
		<ul style="list-style-type: none"> <li>98 25 00</li> <li>98 25 01 SL</li> <li>98 25 02 SL</li> </ul>	Screwdriver for cross recessed screws, Pozidriv®	1	6.5 mm
			Screwdriver (Slim) for cross-recessed screws, Pozidriv®	1	PH 1
				1	PH 2
00 20 12 V04	082552		VDE Screwdriver Set Slotted / Phillips® / Pozidriv®		
		<ul style="list-style-type: none"> <li>98 20 40 SL</li> <li>98 24 01 SL</li> <li>98 24 02 SL</li> <li>98 25 01 SL</li> <li>98 25 02 SL</li> </ul>	Screwdrivers for slotted screws	1	4.0 mm
			Screwdriver (Slim) for cross-recessed screws, Phillips®	1	PH1
				1	PH2
			Screwdriver (Slim) for cross-recessed screws, Pozidriv®	1	PZ1
				1	PZ2
00 20 12 V05	082569		VDE Screwdriver Set Slotted / Phillips® / Pozidriv®		
		<ul style="list-style-type: none"> <li>98 20 25</li> <li>98 20 40 SL</li> <li>98 24 01 SLS</li> <li>98 24 02 SLS</li> <li>98 25 01 SLS</li> <li>98 25 02 SLS</li> </ul>	Screwdrivers for slotted screws	1	2.5 mm
			Screwdriver (Slim) for slotted screws	1	4.0 mm
			Screwdriver (Slim) for cross-recessed screws, Phillips®	1	PH1
				1	PH2
			Screwdriver (Slim) for cross-recessed screws, Pozidriv®	1	PZ1
				1	PZ2

Phillips® is a registered trademark of European Ind. Serv. Ltd.  
Pozidriv® is a registered trademark of Phillips Screw Company

# Crimp Assortments

for wire ferrules

97

- > In a TANOS MINI-systainer® (solid plastic box)
- > T-Loc fastener for one-handed operation: open or close the systainer® with one turn and connect to a second systainer®
- > Opening when connected: fast and simple access to content without disconnecting
- > Two stackable plastic inserts with 6 trays each for connectors
- > With an assortment of wire ferrules with/without collar).



97 90 05



97 90 06

## 97 90 05

- > With Crimping Pliers for wire ferrules 97 71 180

## 97 90 06

- > With Crimping Pliers for wire ferrules 97 71 180

## 97 90 09

- > With Self-Adjusting Crimping Pliers for wire ferrules 97 53 04

## 97 90 10

- > With Self-Adjusting Insulation Stripper 200 ; with Self-Adjusting Crimping Pliers for wire ferrules 97 53 04

## 97 90 12

- > With Self-Adjusting Insulation Stripper 200; with Self-Adjusting Crimping Pliers for wire ferrules (ferrules) 97 53 08

## 97 90 23

- > With Crimping Pliers PreciForce® for wire ferrules 97 52 38

## 97 90 24

- > With Self-Adapting Universal Insulation Stripper MultiStrip 10 12 42 195
- > With Self-Adjusting Crimping Pliers for wire ferrules 97 53 08



97 90 09



97 90 10



97 90 12



97 90 23



97 90 24



Several boxes can be connected with each other

Article No.	EAN 4003773-	Pliers		200 x mm <sup>2</sup>	150 x mm <sup>2</sup>	100 x mm <sup>2</sup>	75 x mm <sup>2</sup>	50 x mm <sup>2</sup>	40 x mm <sup>2</sup>
97 90 05	025535	97 71 180		0.5 / 0.75 / 1 / 1.5 / 2.5	4 / 6			10 / 16	
97 90 06	025542	97 71 180		0.5 / 0.75 / 1 / 1.5	2.5		4 / 6	10	16
97 90 09	028574	97 53 04		0.5 / 0.75 / 1 / 1.5 / 2.5		4 / 6		10	
97 90 10	046202	97 53 04 / 12 40 200		0.5 / 0.75 / 1 / 1.5 / 2.5		4 / 6		10	
97 90 12	048916	97 53 08 / 12 40 200		0.5 / 0.75 / 1 / 1.5 / 2.5		4 / 6		10	
97 90 23	062158	97 52 38		0.5 / 0.75 / 1 / 1.5 / 2.5		4 / 6			
97 90 24	062394	97 53 08 / 12 42 195		0.5 / 0.75 / 1 / 1.5 / 2.5		4 / 6		10	
97 90 00 LE	054009	TANOS MINI-systainer® empty							

**97 90 00**

> With crimping pliers 97 00 215 A

**97 90 21**

> With Crimping Pliers PreciForce® 97 52 36 (for insulated terminals and plug connectors)

**97 90 22**

> With Self-Adapting Universal Insulation Stripper MultiStrip 10 12 42 195

> With Crimping Pliers PreciForce® 97 52 36 (for insulated terminals and plug connectors)

**97 90 25**

> With crimping pliers 97 22 240

**97 90 26**

> With crimping pliers 97 32 240



Article No.	EAN			Cable connectors	Quantity	Cable mm <sup>2</sup>
97 90 21	4003773-062134			Blade Terminal Sockets, 6.3 x 0.8 mm	25	0.5 – 1
					25	1.5 – 2.5
				Cable Connectors, eye type, Ø 4 mm	25	0.5 – 1
				Cable Connectors, eye type, Ø 5 mm	25	0.5 – 1
				Cable Connectors, eye type, Ø 6 mm	25	4 – 6
				Cable Connectors, eye type, Ø 8 mm	25	4 – 6
				Cable Connectors, eye type, Ø 4 mm	25	1.5 – 2.5
				Cable Connectors, eye type, Ø 5 mm	25	1.5 – 2.5
				Cable Connectors, eye type, Ø 6 mm	25	1.5 – 2.5
				Butt Connectors, insulated, Red	25	0.5 – 1
				Butt Connectors, insulated, Yellow	25	4 – 6
				Butt Connectors, insulated, Blue	25	1.5 – 2.5
				97 90 22	062141	
	25	1.5 – 2.5				
Cable Connectors, eye type, Ø 4 mm	25	0.5 – 1				
Cable Connectors, eye type, Ø 5 mm	25	0.5 – 1				
Cable Connectors, eye type, Ø 4 mm	25	1.5 – 2.5				
Cable Connectors, eye type, Ø 5 mm	25	1.5 – 2.5				
Cable Connectors, eye type, Ø 6 mm	25	1.5 – 2.5				
	25	4 – 6				
Cable Connectors, eye type, Ø 8 mm	25	4 – 6				
Butt Connectors, insulated, Red	25	0.5 – 1				
Butt Connectors, insulated, Blue	25	1.5 – 2.5				
Butt Connectors, insulated, Yellow	25	4 – 6				
97 90 25	076971					
					25	1 – 2.5
				Blade Terminal Sockets, 6.3 x 0.8 mm	25	0.5 – 1
					25	1.5 – 2.5
					25	4 – 6
				Blade Terminal Plugs, 6.3 x 0.8 mm	25	0.5 – 1
					25	1.5 – 2.5
				Cable Connectors, eye type, Ø 4 mm	25	0.5 – 1
					25	1.5 – 2.5
				Butt Connectors, insulated, Red	25	0.5 – 1
				Butt Connectors, insulated, Blue	25	1.5 – 2.5
				Butt Connectors, insulated, Yellow	25	4 – 6

97 90 26	079521	 <p>97 32 240</p>	Blade Terminal Sockets, 6.3 x 0.8 mm	25	1.5 – 2.5
				25	4 – 6
				25	0.5 – 1
			Cable Connectors, eye type, Ø 4 mm	25	0.5 – 1
				25	1.5 – 2.5
			Cable Connectors, eye type, Ø 5 mm	25	1.5 – 2.5
				25	4 – 6
			Cable Connectors, eye type, Ø 6 mm	25	4 – 6
			Butt Connectors, insulated, Red	25	0.5 – 1
			Butt Connectors, insulated, Blue	25	1.5 – 2.5
Round Sockets, Ø 4 mm	25	0.5 – 1			
Round Pin Plugs, Ø 4 mm	25	0.5 – 1			
97 90 00 LE	054009	TANOS MINI-systainer® empty			

**Tool Case for Photovoltaics**

- > With tools for photovoltaics
- > Without crimping dies – please order separately (see ref. 97 49) for individual assortment
- > With service tools (hexagonal key) for the change of crimping dies
- > Shock-resistant plastic case
- > Foam insert with recesses for tools, crimping dies and locators
- > Dimensions, exterior (W x H x D): 345 x 80 x 280 mm



**Huber + Suhner**  
**Multi-Contact**  
**Hirschmann**  
**Tyco**  
**Wieland**



Supplied without crimp inserts and locators

Article No.	EAN 4003773-	Content
97 91 01	070351	12 12 11 Precision Insulation Stripper 95 16 165 Cable Shears 97 43 200 Crimp System Pliers

Additional Crimping dies: [www.knipex.com](http://www.knipex.com)

Article No.	EAN 4003773-	Content
<b>98 99 11</b>	026624	1 x 03 07 200 / 1 x 70 07 160 / 1 x 98 20 35 / 1 x 98 20 40 / 1 x 98 20 55 / 1 x 98 24 00 / 1 x 98 42 / 1 x 98 45 125 / 1 x 98 45 250 / 1 x 98 47 10 / 1 x 98 47 11 / 1 x 98 47 12 / 1 x 98 47 13 / 1 x 98 47 14 / 1 x 98 47 17 / 1 x 98 47 19 / 1 x 98 52

Article No.	EAN 4003773-	Content
<b>98 99 12</b>	026631	1 x 03 07 200 / 1 x 70 07 160 / 1 x 98 00 10 / 1 x 98 00 11 / 1 x 98 00 12 / 1 x 98 00 13 / 1 x 98 00 14 / 1 x 98 00 17 / 1 x 98 00 19 / 1 x 98 53 03 / 1 x 98 20 25 / 1 x 98 20 35 / 1 x 98 20 40 / 1 x 98 20 55 / 1 x 98 24 00 / 1 x 98 24 01 / 1 x 98 24 02 / 1 x 98 40 / 1 x 98 47 10 / 1 x 98 47 11 / 1 x 98 47 12 / 1 x 98 47 13 / 1 x 98 47 14 / 1 x 98 47 17 / 1 x 98 47 19 / 1 x 98 52

Article No.	EAN 4003773-	Content
<b>98 99 13</b>	026648	1 x 03 07 200 / 1 x 11 07 160 / 1 x 26 17 200 / 1 x 70 07 160 / 1 x 98 20 65 / 1 x 95 17 200 / 1 x 98 00 10 / 1 x 98 00 13 / 1 x 98 00 14 / 1 x 98 00 17 / 1 x 98 00 19 / 1 x 98 52 / 1 x 98 20 25 / 1 x 98 20 40 / 1 x 98 20 55

Article No.	EAN 4003773-	Content
<b>00 21 15</b>	042853	KNIPEX: 1 x 03 06 180 / 1 x 26 16 200 / 1 x 70 06 160 / 1 x 88 03 180
<b>00 21 15 LE</b>	045175	without tools

Article No.	EAN 4003773-	Content
<b>00 20 12</b>	012412	1 x 03 06 180 / 1 x 26 16 200 / 1 x 70 06 160

Article No.	EAN 4003773-	Content
<b>00 20 13</b>	043287	KNIPEX: 1 x 26 16 200 / 1 x 70 06 160

Article No.	EAN 4003773-	Content
<b>00 20 09 V02</b>	074793	1 x 87 01 180 / 1 x 87 01 250 / 1 x 87 01 300

**Compact Tool Case,  
17 parts**

> With insulated tools for works on electrical installations



**Standard Tool Case,  
26 parts**

> With insulated tools for works on electrical installations



**Tool Roll,  
15 parts**

> With insulated tools for works on electrical installations



**Tool Box,  
7 parts  
for electrical contractors**

> Equipped with 4 KNIPEX pliers and 3 WERA Screwdrivers



**VDE-Electro Set**

> Pliers VDE-tested in conformance with DIN EN/IEC 60900 1000V, pliers chrome-plated; handles with multi-component grips



**VDE-Tool Set  
with 3 WERA screwdrivers**

> Tools VDE-tested in conformance to DIN EN/IEC 60900 1000V, pliers chrome-plated; handles with multi-component covers



**Cobra®-Set**

> Pliers grey atramentized, handles with non-slip plastic coating



**KNIPEX L-BOXX® Electric,  
63-part**

Strong box made of impact- and shock-proof ABS plastic. Equipped with 63 brand name quality tools, some VDE-tested according to DIN EN 60900. For mobile use, several boxes can be securely joined together. Flexible inner partitions.



00 21 19 LB E

Article No.	EAN 4003773-	Content
00 21 19 LB E	081623	1 x 00 11 01 / 1 x 08 26 145 / 1 x 12 42 195 1 x 13 86 200 / 1 x 16 95 01 SB / 1 x 26 26 200 1 x 70 06 160 / 1 x 74 06 200 / 1 x 86 03 180 1 x 87 01 180 / 1 x 97 53 04 / 1 x 98 52 1 x 98 25 01 SL / 1 x 98 20 35 SL
00 21 19 LB	081616	without tools
00 21 19 LB WK	081609	Two-part tool board



00 21 19 LB WK

**Tool Bag "Electric"  
23 parts**

> Contains 23 brand name quality tools, partly VDE tested according to DIN EN/IEC 60900



Article No.	EAN 4003773-	Content
00 21 02 EL	081951	1 x 03 06 180 / 1 x 11 06 160 / 1 x 25 06 160 1 x 70 06 160 / 1 x 98 52 / 1 x 16 95 01 SB 1 x 98 20 25 / 1 x 98 20 35 SL / 1 x 98 20 55 SL 1 x 98 20 65 SL / 1 x 98 24 01 SL / 1 x 98 24 02 SL 1 x 16 20 165

**Universal Tool Case,  
47 parts**

> With insulated tools for works on electrical installations



Article No.	EAN 4003773-	Content
98 99 15 <b>N</b>	084341	1 x 70 06 160 / 1 x 87 26 250 / 1 x 95 16 200 1 x 98 00 10 / 1 x 98 00 13 / 1 x 98 00 14 1 x 98 00 17 / 1 x 98 00 19 / 1 x 98 00 22 1 x 98 01 10 / 1 x 98 01 13 / 1 x 98 01 14 1 x 98 01 17 / 1 x 98 01 19 / 1 x 98 01 22 1 x 98 20 25 / 1 x 98 20 40 SL / 1 x 98 20 55 SL 1 x 98 20 65 SL / 1 x 98 24 01 SL / 1 x 98 24 02 SL 1 x 98 25 01 SL / 1 x 98 25 02 SL 1 x 98 25 02 SLS / 1 x 98 40 / 1 x 98 42 1 x 98 45 125 / 1 x 98 45 250 / 1 x 98 47 10 1 x 98 47 11 / 1 x 98 47 12 / 1 x 98 47 13 1 x 98 47 14 / 1 x 98 47 17 / 1 x 98 47 19 1 x 98 47 22 / 1 x 98 47 24 / 1 x 98 52 1 x 98 53 03 / 1 x 98 64 02 / 1 x 08 26 145 1 x 11 06 160
98 99 15 LE <b>N</b>	060703	without tools



**Tool Case "Vision24" Electric, 20 parts**

> With 20 brand name tools, partly VDE tested according to DIN EN/IEC 60900; heavy duty ABS material, black

Article No.	EAN 4003773-	Content
00 21 20	052166	1 x 03 06 180 / 1 x 12 40 200 / 1 x 16 95 01 SB 1 x 26 16 200 / 1 x 26 26 200 / 1 x 70 06 160 1 x 74 06 160 / 1 x 86 03 180 / 1 x 87 03 250 1 x 95 16 200 / 1 x 98 20 25 / 1 x 98 20 40 SL 1 x 98 20 55 SL / 1 x 98 20 65 SL / 1 x 98 24 01 SL 1 x 98 24 02 SL / 1 x 98 25 01 SL / 1 x 98 25 02 SL 1 x 98 52



**Tool Case "Focus" Electric, 23 parts**

> Contains 23 brand name quality tools, partly VDE tested according to DIN EN/IEC 60900; hard-wearing ABS hard-shell construction with aluminium frame and circular buffer protection

Article No.	EAN 4003773-	Content
00 21 30	051084	1 x 00 11 01 / 1 x 03 06 180 / 1 x 12 40 200 1 x 16 95 01 SB / 1 x 26 16 200 / 1 x 26 26 200 1 x 70 06 125 / 1 x 70 06 160 / 1 x 86 03 180 1 x 87 03 250 / 1 x 92 27 62 / 1 x 98 20 25 1 x 98 20 35 SL / 1 x 98 20 40 SL / 1 x 98 20 55 SL 1 x 98 20 65 SL / 1 x 98 20 80 / 1 x 98 24 00 1 x 98 24 01 SL / 1 x 98 24 02 SL / 1 x 98 25 01 SL 1 x 98 25 02 SL / 1 x 98 56



**Tool Case "BIG Twin" Move Electric and "BIG Twin" Electric 65-part**

> Equipped with 65 brand name quality tools, some VDE-tested according to DIN EN 60900

Article No.	EAN 4003773-	Content
00 21 41	082118	1 x 00 11 01 / 1 x 08 26 145 / 1 x 12 42 195 1 x 13 86 200 / 1 x 16 95 01 SB / 1 x 26 26 200 1 x 70 06 160 / 1 x 74 06 200 / 1 x 86 03 180 1 x 87 01 180 / 1 x 97 53 04 / 1 x 98 20 35 SL 1 x 98 25 01 SL / 1 x 98 52
00 21 41 LE	071549	without tools
00 21 42	084228	Tool Case "BIG Twin" Electric, equipped with 63 brand name quality tools, some VDE-tested according to DIN EN 60900
00 21 42 LE	057673	without tools



00 21 41

**Tool Bag "New Classic Basic"**

Artikel-Nr.	EAN 4003773-	Content
00 21 02 LE	057499	without tools

**Tool Case "Basic"**

Artikel-Nr.	EAN 4003773-	Content
00 21 05 LE	056904	without tools



00 21 02 LE



# Tool Case "Robust 34" Electric

26 parts

00

For the toughest operating conditions: dust-tight, waterproof and temperature resistant















Filled with 26 branded tools for professional electricians

- > Fit to fly case, made from impact-resistant polypropylene
- > Clear, tried and tested layout
- > Padlock eyelets
- > Air pressure compensation valve
- > Document compartment; tool panels made of Con-Pearl® with pouches that can be filled with tools
- > Base tray with aluminium separators, 510 x 419 x 215 mm
- > 34 litre capacity
- > Maximum load of 25 kg

## 00 21 36 LE

- > Case supplied without tools



Article No.	EAN 4003773-				Quantity	Nominal size	g
<b>00 21 36</b>	082583		Tool Case "Robust 34" Electric, 26 parts				10000
			00 11 01	KNIPEX TwinKey®, for all standard cabinets and shut-off systems	Knipex	1	
		  	08 26 145	Needle-Nose Combination Pliers	Knipex	1	145 mm
			12 40 200	Self-Adjusting Insulation Strippers	Knipex	1	200 mm
		  	13 86 200	Pliers for Electrical Installation	Knipex	1	200 mm
			16 95 01 SB	KNIPEX ErgoStrip®, Universal Stripping Tool	Knipex	1	135 mm
		  	70 06 160	Diagonal Cutter	Knipex	1	160 mm
			87 01 180	KNIPEX Cobra®, Hightech Water Pump Pliers	Knipex	1	180 mm
			97 53 04	Self-Adjusting Crimping Pliers for Wire ferrules, with lateral access	Knipex	1	180 mm
			98 52	Cable Knife	Knipex	1	185 mm
				VDE Kraftform Kompakt 60iS/65iS/67iS/16 (Slim) Content 1 each: 1 holding handle 817 VDE; blade length 154 mm: slot 0.4 x 2.5 / 0.6 x 3.5 / 0.8 x 4.0 / 1.0 x 5.5; cross PH 1 / PH 2 / PZ 1 / PZ 2; PlusMinus PZ/S # 1 / PZ/S # 2; TORX® TX 10 / TX 15 / TX 20 / TX 25; voltage tester 0.5 x 30 x 70	Wera	1	
				Folding ruler	Stabila	1	
				Model 70 Electric spirit level	Stabila	1	430 mm
<b>00 21 36 LE</b>	082576		Case supplied without tools				7100

# Tool Case "Robust 45" Electric

63 parts

00

Gas pressure absorber in the hinge: convenient opening of the lid of the case, with no risk of injury from the case closing inadvertently

For the toughest operating conditions:  
dust-tight, waterproof and temperature resistant

Extensively filled with 63 branded tools for professional electricians

- > Fit to fly case, made from impact-resistant polypropylene
- > Clear, tried and tested layout
- > Can be used as trolley: with telescopic handle and wheels
- > Padlock eyelets
- > Air pressure compensation valve
- > Gas pressure absorber in the hinge
- > Document compartment; tool panels made of Con-Pearl® with pouches that can be filled with tools
- > Pneumatically cushioned lid
- > Base tray with aluminium separators, 609 x 428 x 263 mm
- > 45 litre capacity
- > Maximum load of 35 kg

## 00 21 37 LE

- > Case supplied without tools

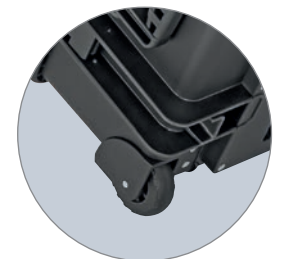

With large easy-roll wheels and telescopic handle for convenient transportation – also on uneven ground

Article No.	EAN 4003773-					Quantity	Nominal size	g
<b>00 21 37</b>	082606		Tool Case "Robust 45" Electric, 63 parts					15000
			00 11 01	KNIPEX TwinKey®, for all standard cabinets and shut-off systems	Knipex	1		
		⚠ 1000 V	08 26 145	Needle-Nose Combination Pliers	Knipex	1	145 mm	
		MM	12 42 195	KNIPEX MultiStrip 10, Automatic Insulation Stripper	Knipex	1	195 mm	
		⚠ 1000 V	13 86 200	Pliers for Electrical Installation	Knipex	1	200 mm	
		MM	16 95 01	KNIPEX ErgoStrip®, Universal Stripping Tool	Knipex	1	135 mm	
		⊖	26 26 200	Snipe Nose Side Cutting Pliers (Stork Beak Pliers)	Knipex	1	200 mm	
		⚠ 1000 V	70 06 160	Diagonal Cutter	Knipex	1	160 mm	
		⚠ 1000 V	74 06 200	High Leverage Diagonal Cutter	Knipex	1	200 mm	
			86 03 180	Pliers Wrench, pliers and a wrench in a single tool	Knipex	1	180 mm	
			87 01 180	KNIPEX Cobra®, Hightech Water Pump Pliers	Knipex	1	180 mm	
		MM	97 53 04	Self-Adjusting Crimping Pliers for wire ferrules, with lateral access	Knipex	1	180 mm	
		⚠ 1000 V	98 52	Cable Knife	Knipex	1	190 mm	
		⚠ 1000 V	98 25 01 SL	Screwdriver (Slim) for cross-recessed screws, Pozidriv®	Knipex	1	187 mm	
		⚠ 1000 V	98 20 35 SL	Screwdriver (Slim) for slotted screws	Knipex	1	202 mm	
				Locksmith's hammer, 300 g	Picard	1		
				8100 SA 8 Zyklop set of metal ratchets; content 1 each: metal ratchet Zyklop, Zyklop sockets 5 - 13 mm, Zyklop extension bars with Flexible-Lock-System, Wobble-Extension, 1 connection part with quick-change chuck, bits in 50 mm length: PH; PZ; TORX®; hexagonal socket	Wera	1	1/4"	
				Joker open-end wrench	Wera	1	10x13 mm	
		⚠ 1000 V		VDE Kraftform Kompakt 60iS/65iS/67iS/16 (Slim) Content 1 each: 1 holding handle 817 VDE; blade length 154 mm: slot 0.4 x 2.5 / 0.6 x 3.5 / 0.8 x 4.0 / 1.0 x 5.5; cross PH 1 / PH 2 / PZ 1 / PZ 2; PlusMinus PZ/S # 1 / PZ/S # 2; TORX® TX 10 / TX 15 / TX 20 / TX 25; voltage tester 0.5 x 30 x 70	Wera	1		
				Pocket Electric mini spirit level	Stabila	1	68 mm	
				Folding ruler	Stabila	1		
				Model 70 Electric spirit level	Stabila	1	430 mm	
				Electrician's Chisel	Rennsteig	1	250x10 mm	
<b>00 21 37 LE</b>	082590		Case supplied without tools					10800

Con-Pearl® is a registered trademark of friedola TECH GmbH

# PLIERS ABC – TECHNICAL BASICS

## BASIC SHAPES OF THE JAWS

flat jaws

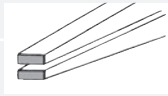

half-round jaws

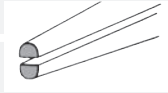

round jaws

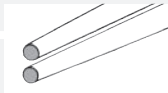

**Cutting Pliers**  
for cutting or nipping (diagonal, centre and end cutters, carpenters' pincers etc.)



**Gripping Pliers**  
(flat-, long-nose and water pump pliers etc.)

## JOINT CONNECTIONS

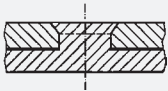

**Forged-in joint axle**

The rivet is part of one handle (forged from one piece)  
> high stability for highest strain  
> long service life

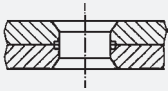

**Joint with inserted rivet**

A proved, sturdy and precise rivet connection for all standard pliers.

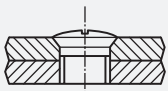

**Bolted joint**

For particularly demanding requirements in terms of precision and smooth operation, e.g. in circlip pliers and cable shears (even the finest multi-stranded conductors have to be cut cleanly).



**Combined Pliers**  
for cutting and gripping (combination, stork beak and radio pliers etc.)



**Special Pliers**  
for special applications, e.g. notching or punching different types of materials (sheet-metal nibbler, tile nibbling pincers etc.)

## TYPES OF JOINTS

**Lap joint**

The two plier halves lie on top of each other but are not milled out.

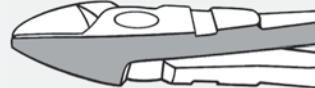

**Single joint**

Half the thickness in each pliers handle is milled away in the joint area so that both handles can be laid into each other.



**Box joint**

One handle on the pliers is slit. The other handle is pushed through this slot. This joint connection can withstand a high level of load and strain because the joint bolt is supported on both sides and the inside handle is guided on both sides.

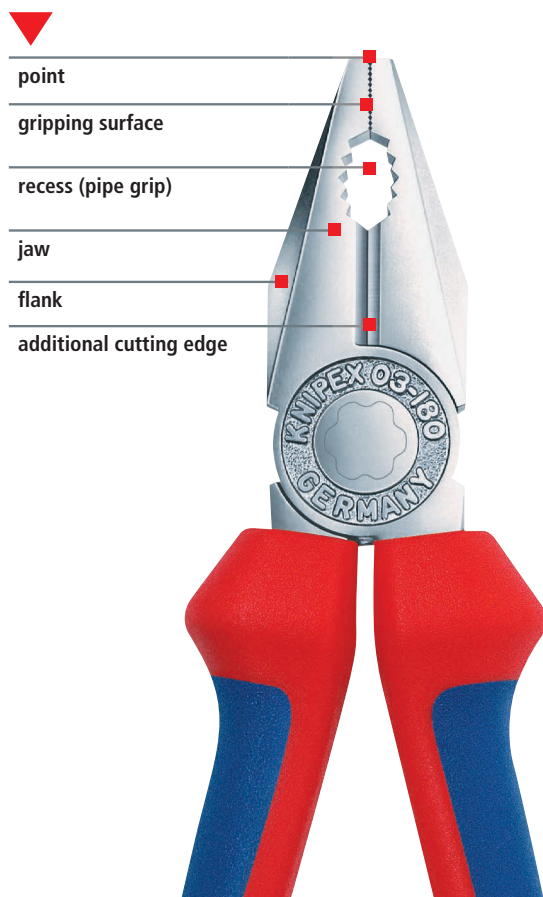
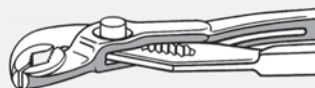

# CUTTING EDGE – TECHNICAL BASICS

## Direction and position of cutting edges

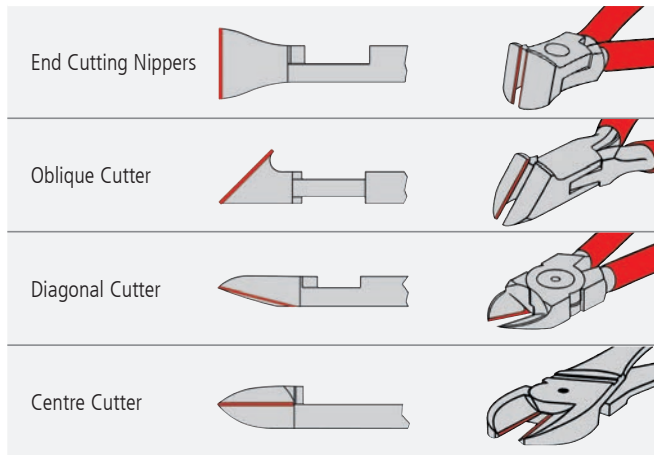

## Cutting edge shapes DIN ISO 5742

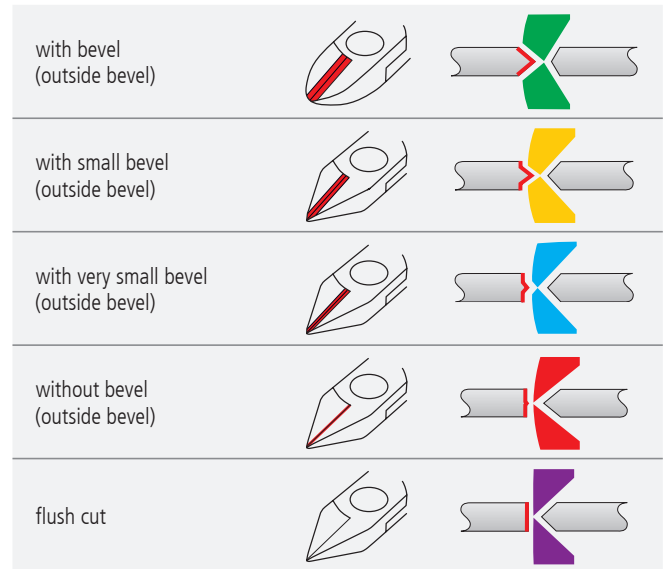

## WIRE CLASSES

	Material examples	Type of wire	Tensile strength	
			N/mm <sup>2</sup>	kp/mm <sup>2</sup>
	Copper, plastics	soft	220	22
	Nail, wire pin	medium-hard	750	75
	Wire rope strand, steel wire	hard	1800	180
	Spring steel wire	piano wire	2300	230

The maximum values indicated always stay for the performance cutting conditions, when the wire is placed as near as possible to the joint.

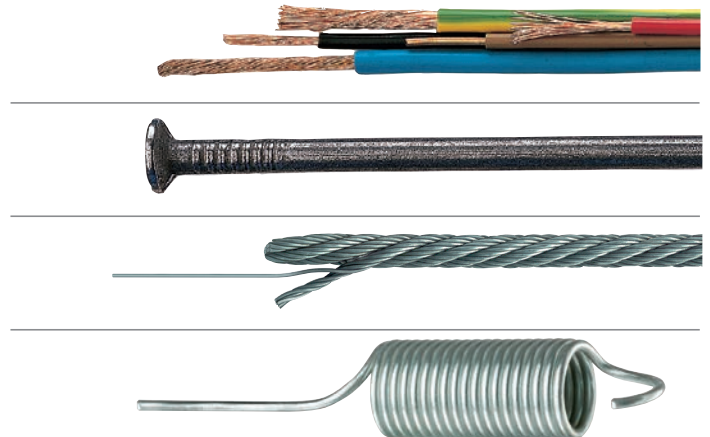

### Safety instructions

- > Each tool should only be used for its specified purpose.
- > When using cutting pliers: beware of wire ends flying off. Wear protective goggles and – if needed – gloves. Be aware of bystanders.
- > Only handles marked with the symbol are insulated.



### Care Tips

A drop of oil on polished surfaces and in the joint will keep the tool in good working order and will increase the service life of your pliers.

# STRUCTURE OF ARTICLE NUMBER

# HEAD/HANDLES

Basic model e. g. KNIPEX Cobra® Hightech Water Pump Pliers	Form e. g. straight	Finish e. g. head polished, handles with mul- ti-compo- nent grips	Length e. g. 250 mm	Accessory e. g. Tethered Tools range
<b>87</b>	<b>0</b>	<b>2</b>	<b>250</b>	<b>T</b>

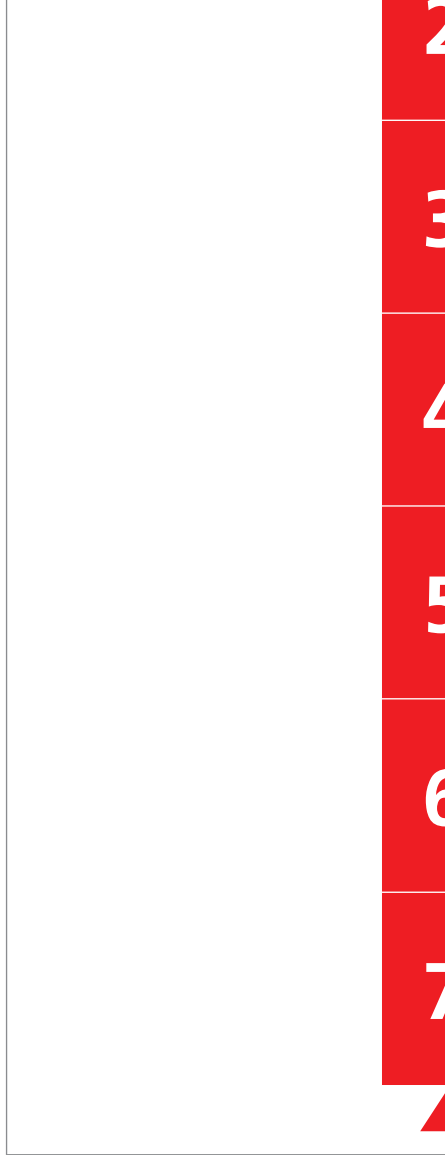

- 0**
- 1**
- 2**
- 3**
- 4**
- 5**
- 6**
- 7**

Pliers black  
atramentized,  
head polished



Head polished,  
handles plastic coated

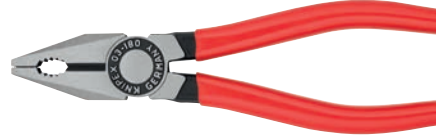

Head polished,  
handles with  
multi-component grips



Pliers chrome plated,  
handles plastic coated



Pliers chrome plated



Pliers chrome plated,  
handles with multi-  
component grips



Pliers chrome plated,  
handles insulated with  
multi-component grips,  
VDE-tested



DIN EN 60900 / IEC 60900   1000 V

Pliers chrome plated,  
handles with dipped  
insulation,  
VDE-tested



DIN EN 60900 / IEC 60900   1000 V

# INDEX

## New Products

KNIPEX StepCut .....	7	Wire stripping tool for coax and data cable.....	37
KNIPEX PreciStrip16 .....	8	Stripping Tool for coax cables .....	37
KNIPEX Cobra® XS .....	10	Crimping Pliers.....	37
Pliers Wrench – 300 mm length.....	12	Stripping Tool for data cables.....	37
KNIPEX TubiX® .....	14	KNIPEX PreciForce® .....	38
KNIPEX CoBolt® S – with recess .....	15	Crimping Pliers for Western plugs .....	38
Pipe Cutter for plastic composite pipes .....	16	KNIPEX MultiCrimp® Crimping Pliers with changer magazine .....	39
Pipe Cutter for multilayer and pneumatic hoses.....	16	Crimping Pliers short design .....	39
KNIPEX X-Cut® Compact Diagonal Cutter .....	17	Self-Adjusting Crimping Pliers for wire ferrules.....	40 / 41
Diagonal Cutters .....	18	Crimping Pliers for wire ferrules .....	42
High Leverage Diagonal Cutters.....	18	Crimping Pliers .....	42
Magnetic LED Lamp .....	18	Crimp System Pliers for exchangeable crimping dies.....	43
Pliers for Electrical Installation .....	19	KNIPEX eCrimp .....	43
Electricians' Pliers.....	20	Crimping Dies .....	44
Stripping Pliers.....	20	Range boxes of wire ferrules.....	45
KNIPEX StriX® .....	21	F-compression connector.....	45
Insulation Strippers.....	22	KNIPEX CoBolt® S .....	45
Diagonal Insulation Stripper .....	22	Four-Mandrel Crimping Pliers .....	46
Snipe Nose Side Cutting Pliers .....	22	Compression Tool .....	46
Needle-Nose Combination Pliers.....	23	Insertion tool .....	46
Combination Pliers .....	23	Pipe Cutter .....	47
Long Nose Pliers .....	24	Vinyl Shears .....	47
Flat Nose Pliers .....	24	Notching Pliers.....	47
KNIPEX Cobra®.....	24	Wire Rope Cutter .....	48
KNIPEX Alligator® .....	24	KNIPEX Twistor16® .....	48
Cable Shears .....	25	Wire Rope Cutters (forged).....	49
Cable Shears with twin cutting edge.....	25	KNIPEX CoBolt® .....	49
Cable Cutters (ratchet action) .....	26	Compact Bolt Cutters .....	49
Cable Cutters (ratchet principle).....	26	Pen-Style Control Cabinet Key .....	49
Cable Cutters (ratchet action) for steel wire armoured cables (SWA cable) ..	27	Control Cabinet Keys.....	50
ACSR Cable Cutter (ratchet action) .....	27	KNIPEX TwinKey® .....	50
Cable Shears .....	28	Screwdriver Set .....	51
Cable Shears (ratchet action) .....	28	Crimp Assortments .....	52 / 53 / 54
Electronic Super Knips® .....	29	Tool Case for Photovoltaics.....	54
Precision Electronics Diagonal Cutters .....	29	Tool Assortments, Cases and Sets .....	55 / 56 / 57
Electricians' Shears.....	30	Tool Case "Robust 34" Electric.....	58
Stripping Knives .....	30	Tool Case "Robust 45" Electric .....	59
Cable Knives .....	30		
KNIPEX TwistCut® .....	31		
Electricians' Shears .....	31		
KNIPEX ErgoStrip® Universal Stripping Tool.....	32		
Automatic Stripping Pliers .....	33		
Folding Knife for Electricians .....	33		
Stripping Tools .....	34		
Universal Stripping Tools.....	34		
KNIPEX MultiStrip 10 Automatic Insulation Stripper .....	35		
Automatic Insulation Stripper .....	35		
Self-Adjusting Insulation Strippers .....	36		
Automatic Insulation Stripper for flat cable .....	36		

It is not permissible to copy the catalogue or parts of it in any way without our approval.

Subject to model modifications and technical changes. Illustrations, dimensions and weights are just approximate.

No liability is assumed for misprints or errors. Printed in the Federal Republic of Germany.

KNIPEX-Werk C. Gustav Putsch KG

**KNIPEX-Werk**  
**C. Gustav Putsch KG**

42337 Wuppertal  
Germany

Tel.: +49 202 47 94-0  
Fax: +49 202 47 74 94

info@knipex.com  
www.knipex.com

Follow us on:   



Your dealer